



Anark Collaborate User Reference

CONTENTS

Introduction.....	5
Content Publishing to Anark Collaborate	6
User Reference	9
Anark Collaborate Authentication	9
Logging in to Anark Collaborate	9
Signing Out of Anark Collaborate	9
Account Page.....	10
Preferences.....	10
Security - Changing Anark Collaborate Password.....	10
Uploading a Profile Picture.....	11
Collaborate	13
Newsfeed Realtime Updates	13
Filtering Newsfeed Conversations.....	13
Favorites	14
Favorites	15
Files.....	15
Uploading	16
Viewing.....	17
Sharing.....	18
Activities	19

Anark Collaborate User Reference

Activity Creation	19
Activity Start and End Dates	21
Activity Page	21
User and Content Metadata	21
Conversation Anchors	22
Reports	22
Work Items	23
Work Item Creation	23
Work Item Information Page	25
Adding Content Items and Files to a Work Item	26
Work Item History Page	28
Search Page	28
Content Search	29
Work Instruction Search	30
Activity Search	30
User Search	31
Group Search	31
Activity Groups Search	31
Template Search	31
Anark Collaborate Users and Groups	32
User Roles	32
User Creation	32
Deactivating and Reactivating Anark Collaborate Users	33
Editing Anark Collaborate Users	34
Creating Groups	34
Content Archival	35
Viewable Content	36



Template Uploading	37
Fields.....	38
Activity Groups	39
Activity Group Creation	39
Editing and Deleting an Activity Group.....	40
Conversations	41
Creating New Conversations	41
Editing Conversations	41
Deleting Conversations.....	41
Private Conversations.....	42
Comments and Replies	42
Creating Comments.....	42
Rich Text	42
Mentions	43
Adding Contextual Information to Comments	44
Markup Tools.....	45
Replying to Comments	47
Editing and Deleting Comments and Replies.....	49
Pop-up Callouts	50
Configuration.....	50
Publish	50
Template API	52
Viewing Callouts in Anark Collaborate	52
3D Axis.....	54
Configuration.....	54
Viewing Axis Labels In Anark Collaborate.....	55
Multiple Selections.....	56



Anark Collaborate User Reference

Multiple Selections with the Control-key	56
Multiple Selections with the Control-key and Marquee Selection tool	56
Multiple Selections with the CAD Tools Select Button	57



INTRODUCTION

Anark Collaborate provides ubiquitous access to technical content with collaboration to knowledge workers throughout the enterprise and supply chain.

Using Anark Workstation and Anark Publish, technical data such as 2D PDF and TIFF drawings, JPEG images, 3D CAD (with optional support for MBD), and data such as parts lists, manufacturing notes, material specifications, requirements, and field service data, together with attribute data from a variety of data sources, can be published from authoritative systems into Anark Collaborate for access and collaboration among engineering, supply chain, manufacturing, quality, and field service users. Additionally, ad-hoc files can be securely shared with web-based collaboration through a drag-and-drop browser-based UI.

With Anark Collaborate, knowledge workers within the extended enterprise can access and collaborate with fit-for-purpose technical web content that is synchronized with authoritative repositories.

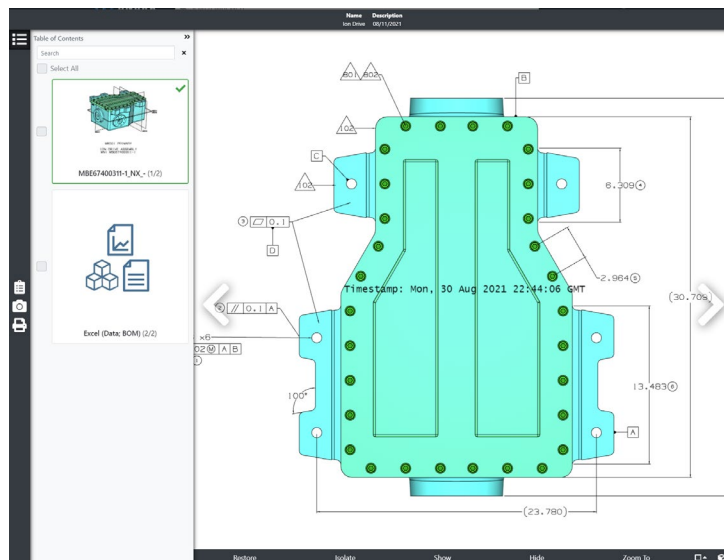
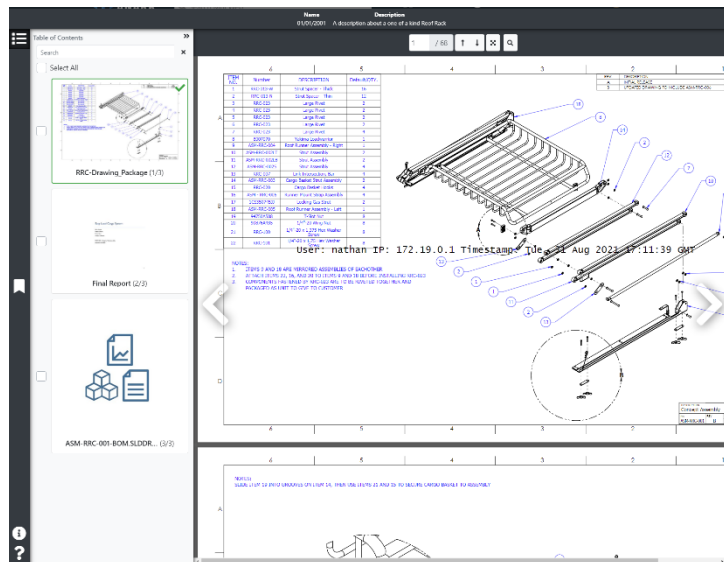

CONTENT PUBLISHING TO ANARK COLLABORATE

Content can be published to Anark Collaborate from either **Anark Workstation** or **Anark Publish** by Users that have been granted the Content Author Role or by Anark Collaborate Users contained within a Group that has been granted the Author Role.

To publish content to Anark Collaborate from Anark Workstation, click **File > Publish to Anark Collaborate...** (Here users will see the same publishing preferences for Anark Collaborate that are available by selecting **Preferences...** under the **Tools** menu).

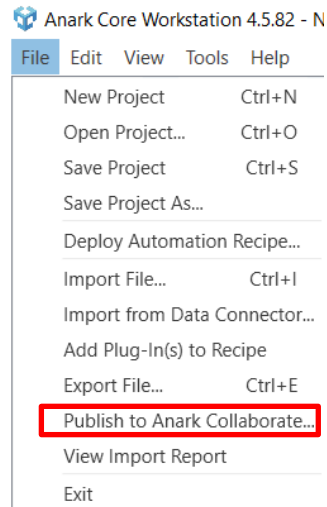

The **Anark Collaborate Options** dialog will appear. These settings can be modified to differ from the default preferences for the current content.



Publishing Connection

Server URL *

Upload Login & Password * ✓

Template & Attachments

Template Id *

Attachments

Metadata

Content Name *

Content Description

Custom

Model Status		string
Version		string
Revision		string
TRADE RESTRICTION		boolean
REGION		string
BLACK PROGRAM		boolean
ITAR RESTRICTED		boolean
ITAR		boolean

Advanced
▼

Save these settings

Anark Collaborate Options (all fields below are mandatory unless otherwise noted):

- **Server URL** — The root URL of the users Anark Collaborate server.
Examples: **https://www.yourserver.com** or **http://yourserver** or **https://192.168.0.123**, etc.
- **Upload Login** — The name of a **User** with the Create-Update-Delete-ContentItem role permission to upload to the Anark Collaborate server.
- **Upload Password** — The password for the **User** with permission to upload to the Anark Collaborate server.
- **HTML Template Id** — The Id of an uploaded HTML Template. Once a valid Server URL, Upload Login, and Upload Password have been entered, the Template Id can be selected from a menu of available templates.
- **Attachments** — (OPTIONAL) Additional files to attach to the content.
- **Content Name** — The name of the content.
- **Content Description** — (OPTIONAL) The description of the content.
- **Content Properties** — (OPTIONAL) Set custom properties at the content level. This Metadata is searchable inside of the Anark Collaborate content search.
- **Enable full validation of server certificates** — Disable this option to accept server certificates with unknown root CAs when using TLS. This allows users to use https with self-signed certificates. It is recommended to leave this option enabled on untrusted networks.
- **Server Communication Timeout** — The maximum amount of time (in seconds) to wait for a response from the server before abandoning the upload.



Anark Collaborate User Reference

- **Cross-section cap color** — The section cap color applied to a 3D model if applicable.
- **View Scope** — Which views are exported.

Once all required fields have been filled, click **Publish** to publish the content to Anark Collaborate.

For more information on publishing Anark Collaborate content from Anark Publish, please refer to the *Anark SDK Reference*. For further instructions on how to use Anark Workstation, please refer to the *Anark Workstation User Reference*.



USER REFERENCE

ANARK COLLABORATE AUTHENTICATION

User authentication can be achieved by direct integration of Anark Collaborate with a company's SSO or AD infrastructure. Optionally, user authentication can be achieved independently with Anark Collaborate using a local **User Id** and **Password**. This reference assumes the latter configuration.

LOGGING IN TO ANARK COLLABORATE

To login to Anark Collaborate, users will need to enter values into the **User Id** and **Password** fields on the Anark Collaborate Login Page. If users have any complications logging in, they should contact their Anark Collaborate Administrator. The Anark Collaborate Administrator can reset the user's User Id and Password. Successful login will direct users to their Anark Collaborate Home page.

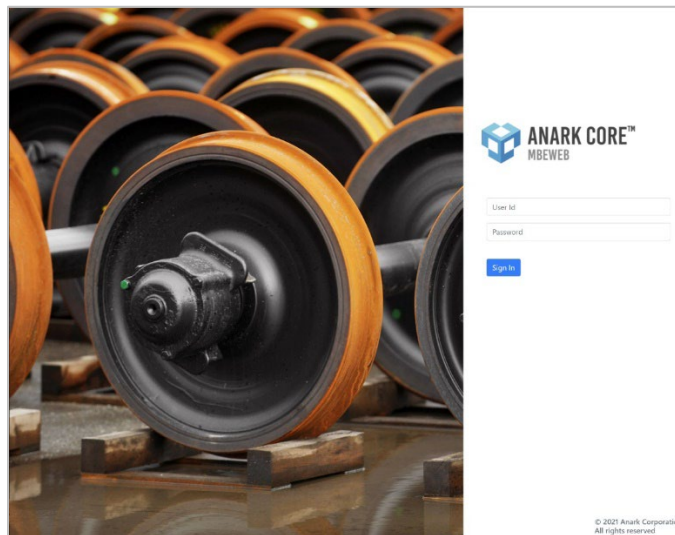

SIGNING OUT OF ANARK COLLABORATE

Anark Collaborate Users can sign out of Anark Collaborate from any page by clicking on their User Icon at the top-right corner of the page. A dropdown menu will appear with the options to manage your **Account**, **Favorites**, **Security**, or to **Sign Out**. Selecting **Sign Out** will sign the active user out of Anark Collaborate and redirect them to the Anark Collaborate Login Page.

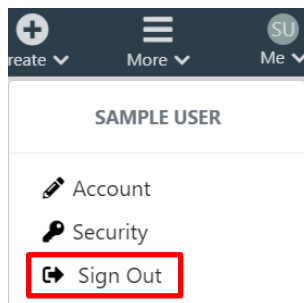

ACCOUNT PAGE

Anark Collaborate Users can access and manage their account from any page by clicking on their User Icon at the top-right corner of the page. A dropdown menu will appear with the options to manage your **Account**.

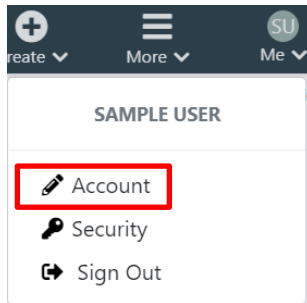

When **Account** is selected, the active user will be redirected to their **Account Page**. This page provides users the ability to manage their account preferences and password security by clicking on the appropriate tabs on the left.

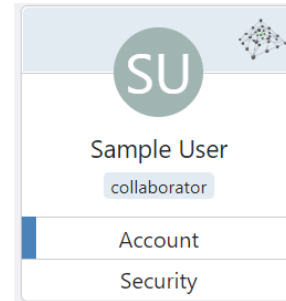

PREFERENCES

Anark Collaborate Users have the option to opt-out of email notifications and select their landing page after logging into the system.

Email notifications is enabled (opt-out) by default for all Users. Changes to preferences are automatically saved.

Home page preference allows for setting your landing page to either Collaborate (Newsfeed) or Files (file sharing).

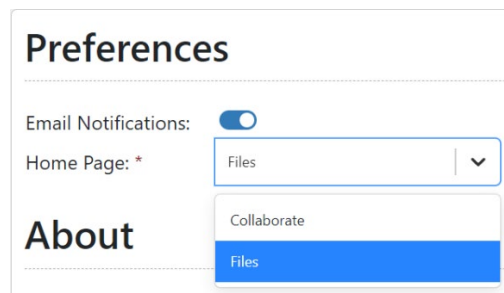

SECURITY - CHANGING ANARK COLLABORATE PASSWORD

From the **Account Page**, or clicking **Security** from their navbar User-icon, users can click on the *Security* tab which allows them to enter their old password, their new password, and a confirmation of their new password. Once values have been entered in all 3 fields, the user can finalize the password change by clicking **Update**.



Change Password

Current Password

New Password

Confirm New Password

[Update](#)

UPLOADING A PROFILE PICTURE

On the **Account Page**, users have the option to upload a profile picture by selecting the edit button located on the user icon.

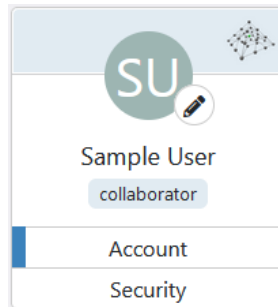

If no profile picture is currently set, an upload modal will be displayed with the option to upload a new image. The accepted file formats for the profile picture are PNG and JPG.

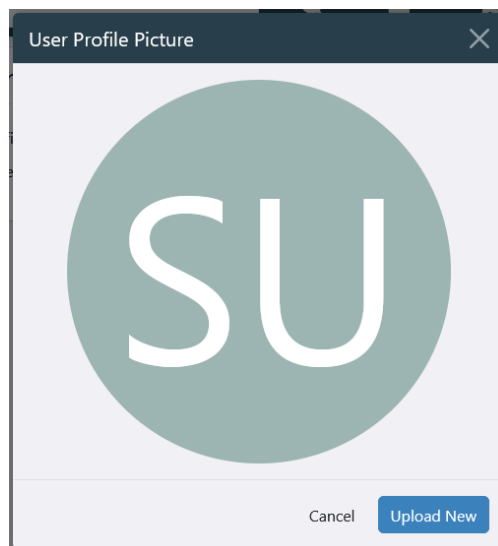

Upon uploading a new image, the photo editor will be launched, enabling users to crop their image or flip it.

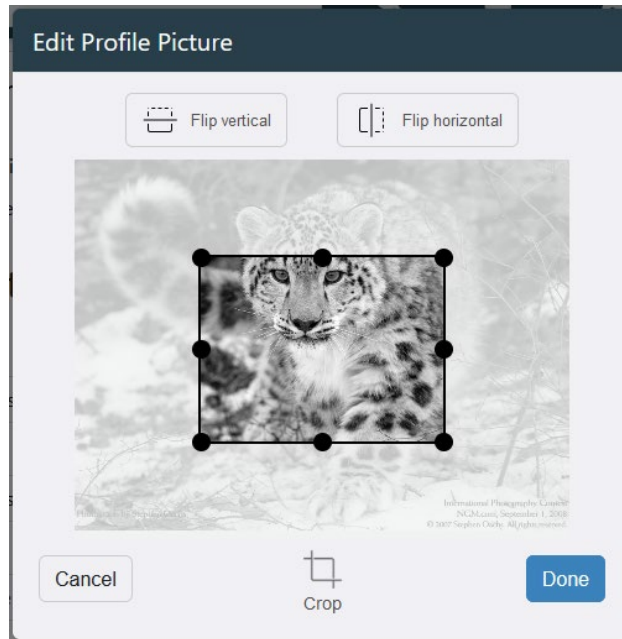

After making the desired adjustments, the user can click the **Done** button to save the new picture as their profile image. Once a profile picture has been uploaded, users will have additional options to **upload** a new photo, **edit** the current photo, or **delete** the current photo.

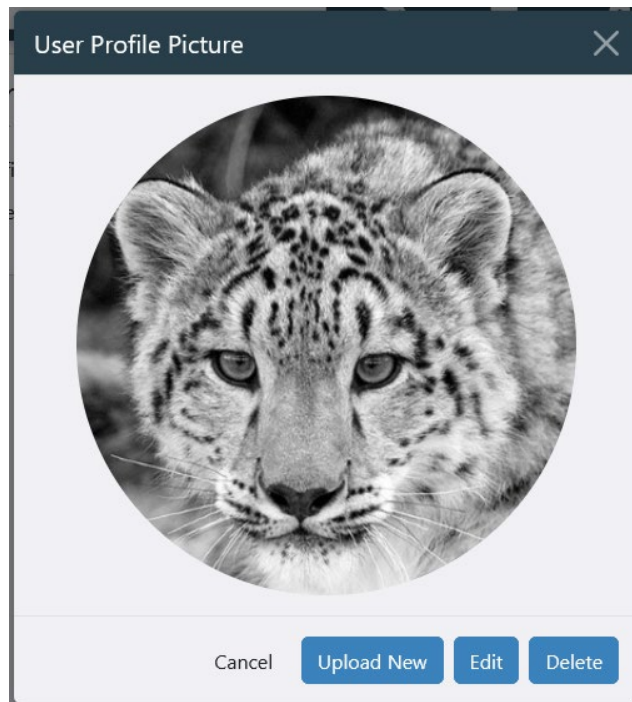

COLLABORATE

The Collaborate page consists of the **Newsfeed**, and a quick access list of **Favorites**.

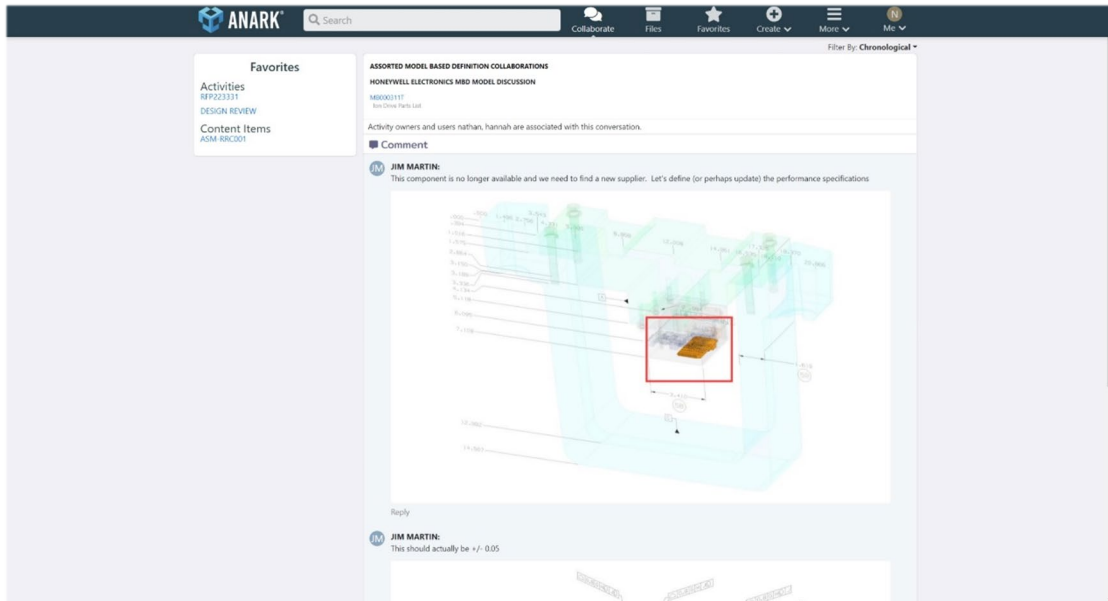

NEWSFEED REALTIME UPDATES

Anark Collaborate automatically updates a user's Newsfeed when an Activity, Conversation, or Comment is edited or deleted by any other user. Users will automatically receive new comments and conversations in their Newsfeed as they are created.

FILTERING NEWSFEED CONVERSATIONS

By default, the Collaborate Newsfeed uses the **Chronological** filter, with the most recently updated Conversation at the top. To change the Newsfeed Filter, select the **Filter By:** dropdown menu and select either **Chronological**, **My Conversations**, or **Activity**.

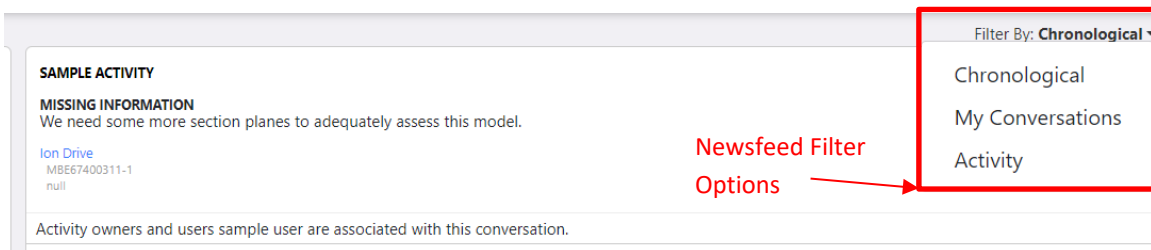

The **My Conversations** filter shows only Conversations that were created by the active user. The **Activity**

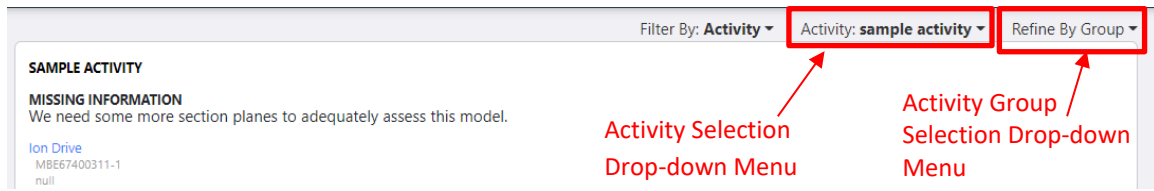

filter shows Conversations in a selected Activity. The Activity filter can be refined further by selecting a certain Activity Group, which will only display Conversations available to that Activity Group.

FAVORITES

The left side panel of the Collaborate page contains quick-access links to your favorite Contents, Activities, Work Instructions, and Work Instruction Executions. Clicking on the title **Favorites** will take you to the Manage Favorites page and clicking on the favorited item will navigate the page to that item.

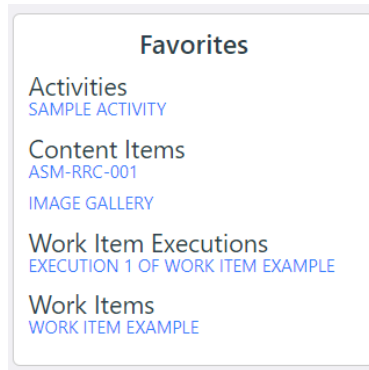

FAVORITES

From the *Favorites* tab, or clicking **Favorites** from their navbar User-icon, users can view or manage (remove) their favorited Content Items, Activities, Work Instructions, and Executions.

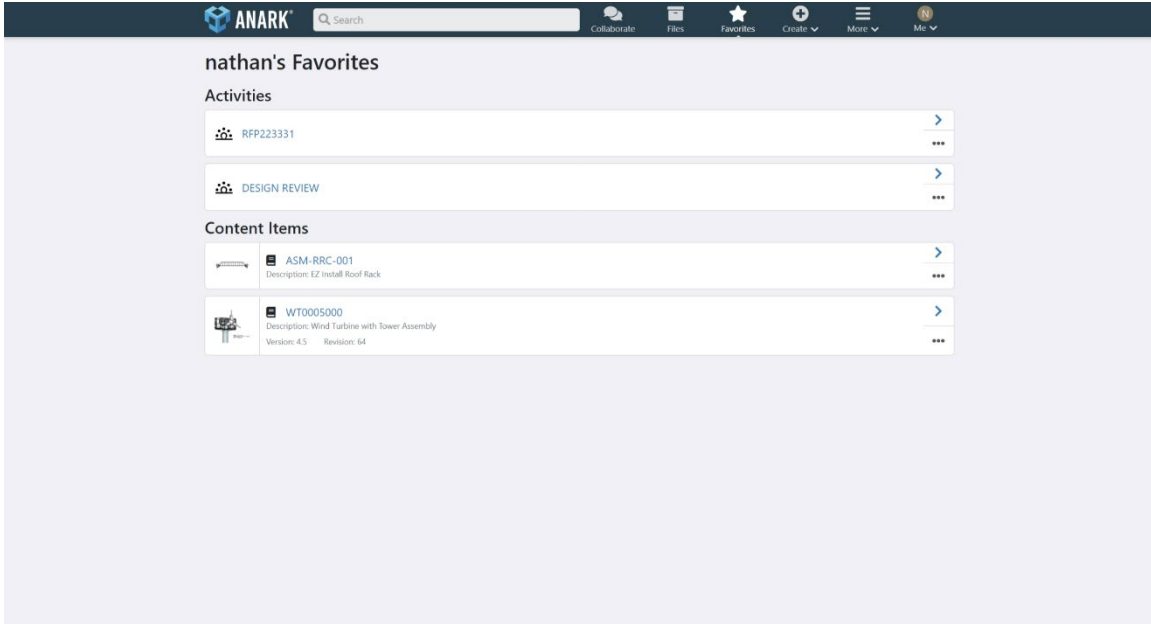

FILES

The Files page, also referred to as My Files, is a file storage solution for uploading your own files and sharing with others for collaboration.

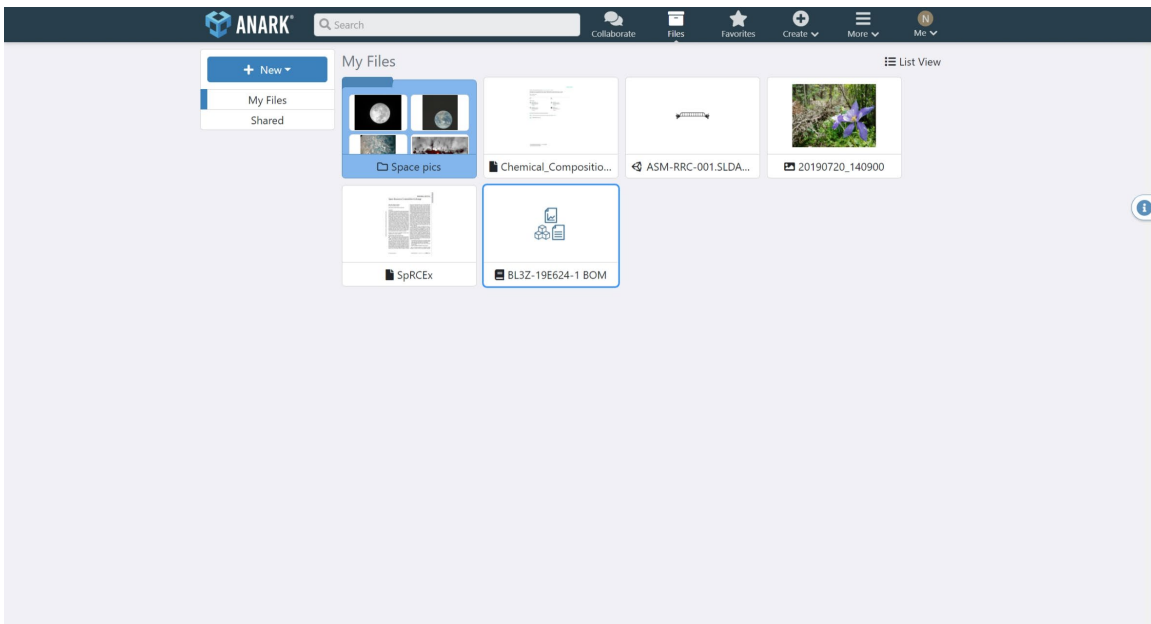

Any file can be uploaded, but only files of certain types can be viewed. Below is a list of all file types and associated privileges.

Viewable:

- 3D CAD (Must upload as Viewable content).
 - SolidWorks
 - STEP
- PDF
- Images (JPG, PNG, TIF)
- Video (MP4)

Downloadable:

- 3D CAD (Must upload as Downloadable content).
- All other file types

UPLOADING

To upload a file, or create a folder, click on the blue **New** button on the My Files or an Activity Page. Dragging and dropping a file into the browser window will also trigger an upload.

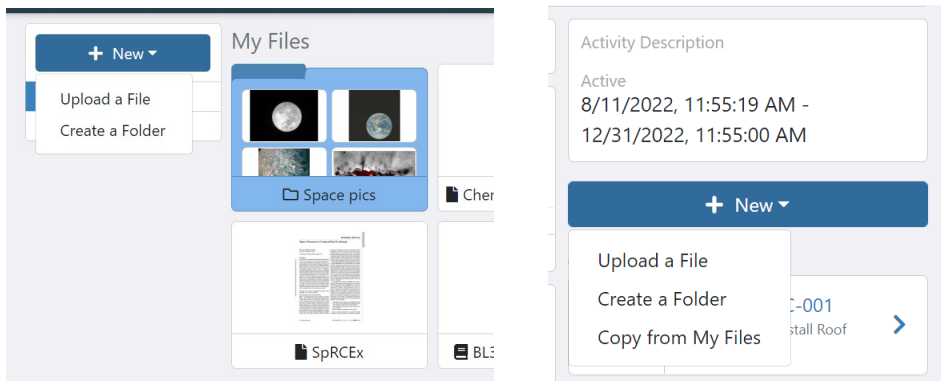

When the upload modal appears, you may change the name of the file if you wish. For convenience, the original file name is shown below the given name:

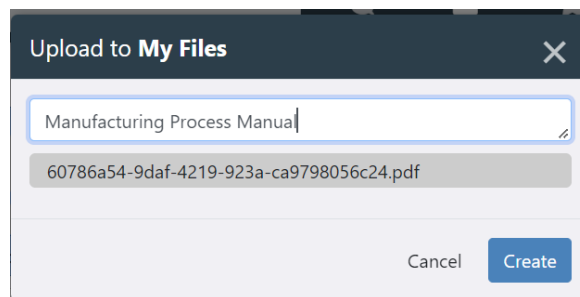

If uploading a 3D CAD assembly, you must first select the top-most assembly file. After selecting the assembly, you will have the option to drop or select all supporting sub-assemblies or parts. Additionally, you will have the option to upload the model as Viewable (can be viewed, marked up, inspected but not downloaded) or Downloadable (can be downloaded but not viewed). All referenced files will be uploaded with the top-most assembly. Do not zip the referenced files if you intend for the model to be viewable, they must be added as individual files. When selecting reference files, multi-select is available.

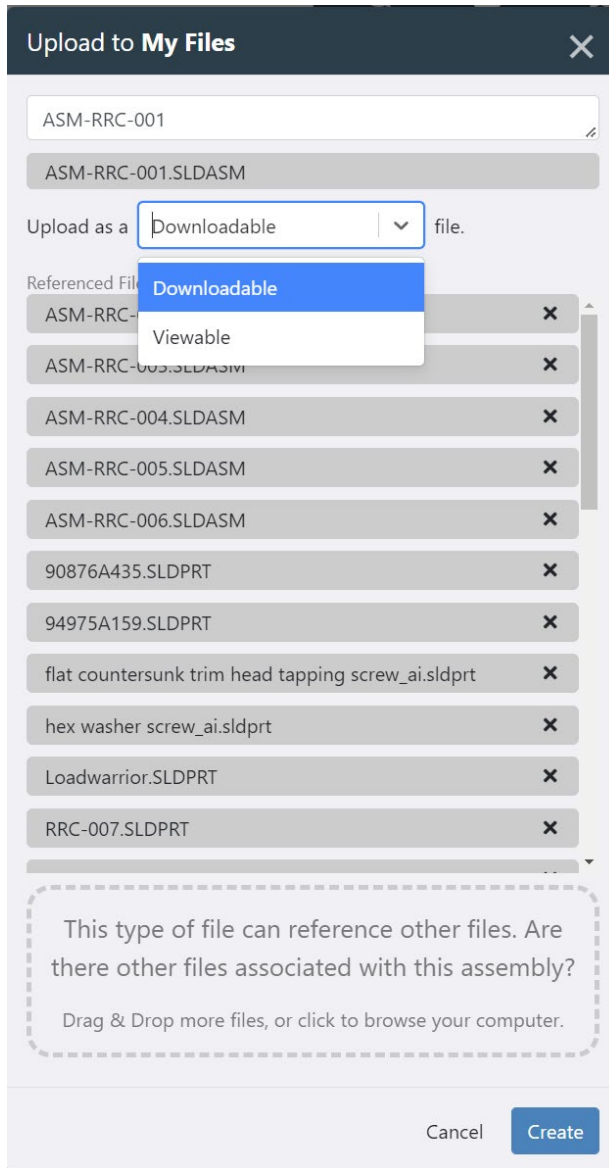

VIEWING

To view your file, simply double-click on the file and it will open. To see details and options for sharing, downloading, editing, or deleting your file, you can either right-click to see a context menu, select the ellipsis next to each file, or single-click and examine it on the drawer that opens to the right.



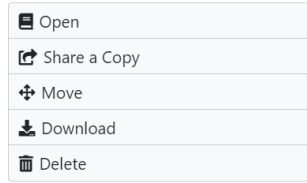

Double-clicking a folder will open the folder to inspect all files and folders inside. A bread crumb path is presented at the top of the screen to show the current level with My Files.



SHARING

Sharing is centered around Activities for collaboration. When sharing a file(s) or folder(s), a new Activity is created and all selected users and groups that you wish to share the file with, are added to the Activity. This enables convenient and efficient collaboration around the shared files with as many people in as many contexts as needed. There is no limit to how many files can be shared to a single Activity.

To share one or more files or folders, select the items you wish to share – to select multiple files hold the CTRL key while clicking on items or long-press on mobile. A details drawer will appear with an option to **Share a Copy**. A dialogue will appear with input fields to create an Activity and invite users to collaborate with you. Once you have clicked “Create” you will be redirected to the new Activity where you can start a conversation about the file(s) you just shared.

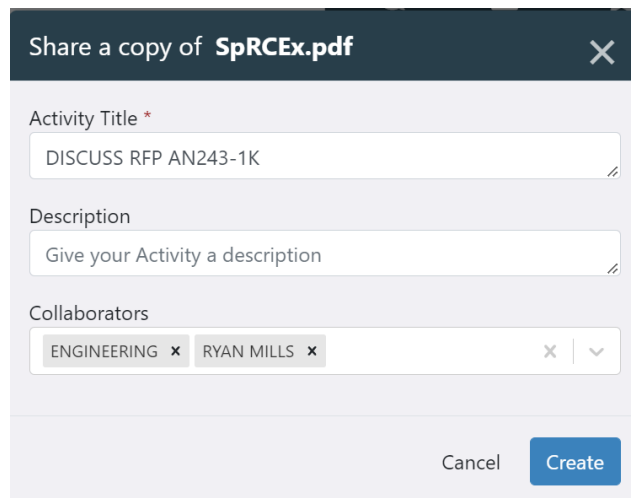

Files can also be shared to an existing Activity by any user participating in the activity. For traceability, all shared files to any activity are copied instead of referenced. This way, if a user is later removed from the activity or the file is deleted from that user’s Files, the conversations around that file are preserved and access to the file is not revoked.

On the My Files page, selecting the “Shared” tab will show all files and folders that have been shared with you through an Activity. In the example below, the blue text is a link to the Activity you are participating



in, and the files and folders below the text are the shared items in that Activity.

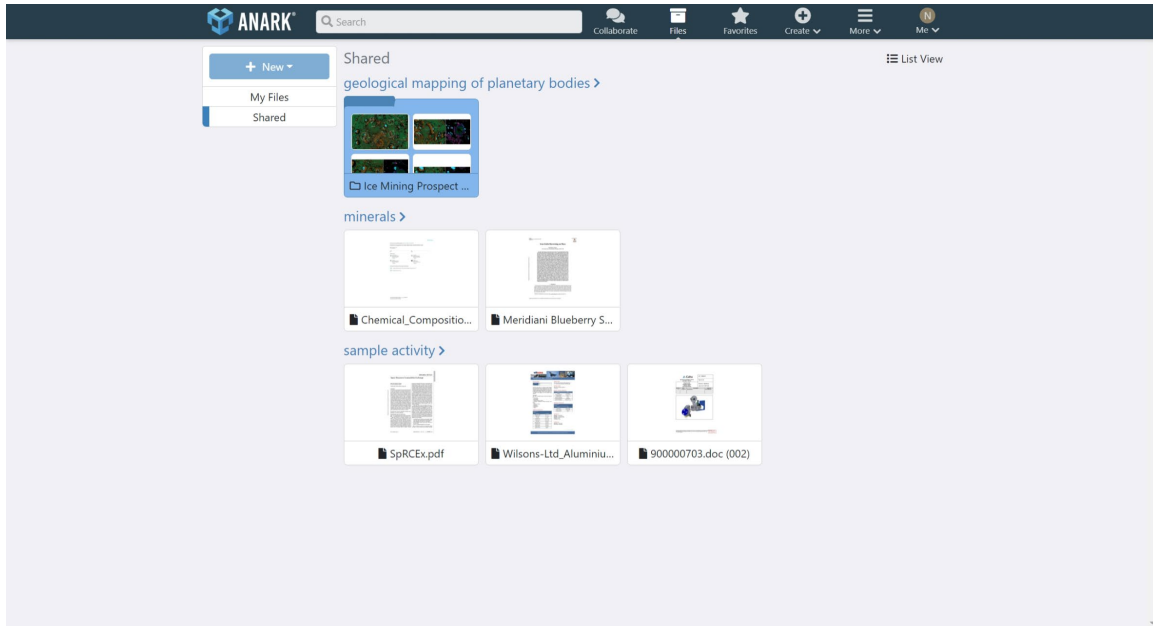

ACTIVITIES

ACTIVITY CREATION

Users that have the Administrator or Collaborator Role can create Activities. Activities host Conversations between users and Activity Groups about chosen content. To create an Activity, select the '+' **Create** icon in the top right corner of the Navbar then select **Create Activity** from the **Create** dropdown menu appear. On certain pages the **Create** button is in the **More** button.

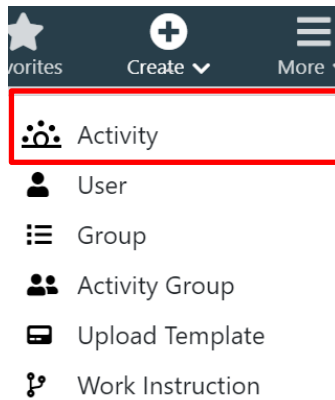

Selecting **Activity** will open a modal allowing users to enter a **Title** and optional **Description**. Upon clicking "Create" the page will navigate to the created activity in edit mode. In this mode, the **Title**, **Description**, **Start Date**, and **End Date** are editable. Additionally, the **+Add** button will have two edit-mode-only



options **Add a Contributor** and **Add a Content Item**. The other three options **Upload a File**, **Create a Folder**, and **Copy from My Files** underneath **+Add** are always available to all contributors in the activity.

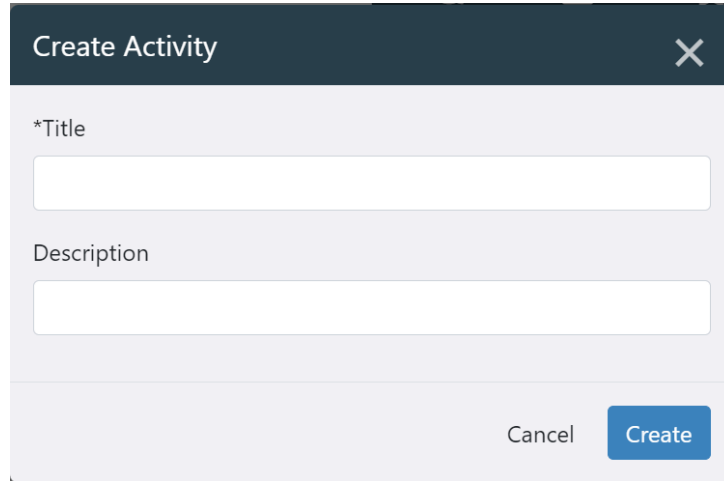

The image shows a modal window titled "Create Activity" with a close button (X) in the top right corner. The form contains two text input fields: the first is labeled "*Title" and the second is labeled "Description". At the bottom right of the modal, there are two buttons: "Cancel" and "Create".

Selecting **Add a Contributor** will open a modal for adding activity users and/or activity owners. Selecting **Add a Content Item** will open a modal for adding content items to the activity.

When creating an activity, by default, start and end dates will be applied, starting today and ending 30 days from now, respectively. When finished editing, click on the cog wheel and select **View Activity**.

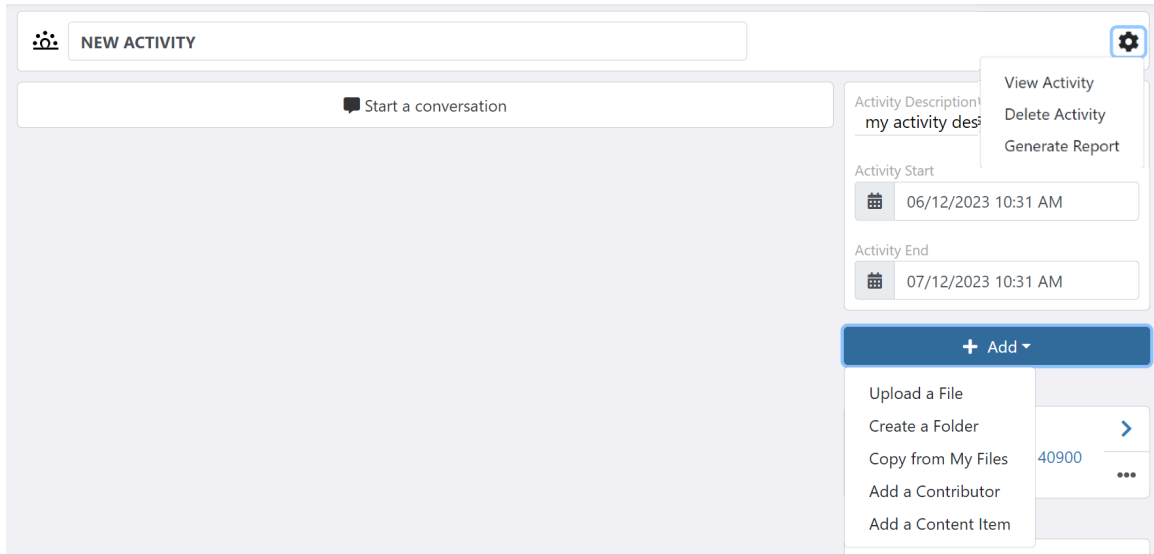

The image shows a screenshot of the "NEW ACTIVITY" interface. At the top, there is a search bar with a magnifying glass icon and the text "NEW ACTIVITY". Below this is a large text area with a "Start a conversation" button. On the right side, there is a settings menu with a gear icon. The menu includes options for "View Activity", "Delete Activity", and "Generate Report". Below the menu, there are two date pickers: "Activity Start" set to "06/12/2023 10:31 AM" and "Activity End" set to "07/12/2023 10:31 AM". At the bottom, there is a blue "+ Add" button with a dropdown menu. The dropdown menu includes options for "Upload a File", "Create a Folder", "Copy from My Files" (with a value of "40900"), "Add a Contributor", and "Add a Content Item".



The screenshot displays the Anark Collaborate interface for an activity titled "GEOLOGICAL MAPPING OF PLANETARY BODIES". The interface includes a top navigation bar with icons for Collaborate, Files, Favorites, Create, More, and Me. The main content area shows a conversation feed with comments from users Nathan, Lars, and Eric. On the right side, there is a sidebar with several sections: "Activity Description" (highlighted with a gear icon for settings), "Content Items" (highlighted with a blue arrow, showing "Excavation Rover Design"), "Shared Files" (highlighted with a blue arrow, showing "ICE MINING PROSPECT SITES"), "Owners" (listing Nathan), "Users" (listing Ben and Dave), and "Groups" (listing SPR507). A "New" button is also visible in the sidebar. Annotations with arrows point to these specific elements, explaining their functions.

Options to edit, delete, or generate a report. Only the activity owner or users with permission to manage activities, can see the icon.

Available for all participants to upload or share files.

Shared files and global content items

Users and groups that are participating in the activity.

ACTIVITY START AND END DATES

All activities are created with a start and end date. Before the activity begins and after the activity ends, the entire activity will be *read only*. Users will not be able to create or edit conversations or create or edit comments; however, the activity owner will still be able to manage the activity and make any changes needed.

ACTIVITY PAGE

The Activity Page is like the Collaborate page in that it too contains a feed of conversations but limited to a particular activity. The Activity Page is the only page where users can create new conversations, see everyone and every group that is participating in the activity, and see all content that is part of the activity, provided the user has been given access to the content. If the current user does not have access to a content, they will not see it on the Activity Page nor will they see any conversations that reference the content.

USER AND CONTENT METADATA

Depending on your company's Anark Collaborate configuration, users and content may show metadata below the name/title. This metadata is a convenience for companies that have multiple users with the same name or multiple content with, for example, different revisions and the same title.



For security, if a user does not have access to a content, that user will not see that content or any content metadata on the Activity Page. In other words, content metadata is access controlled in the same manner as the content itself.

CONVERSATION ANCHORS

In the activity information pane users will see conversation links with the title of the conversation. These links serve as anchors and therefore clicking on any one of these conversations will scroll the feed to that conversation.

REPORTS

Activity owners have an additional option in the cog menu to generate a PDF report. Upon clicking on this option, a menu will appear allowing activity owners to select the conversations for which to include in the report - can be none, some, or all. Selected conversations will include all comments and markup images. Reports will also include all activity information including contents, participants, and activity metadata.

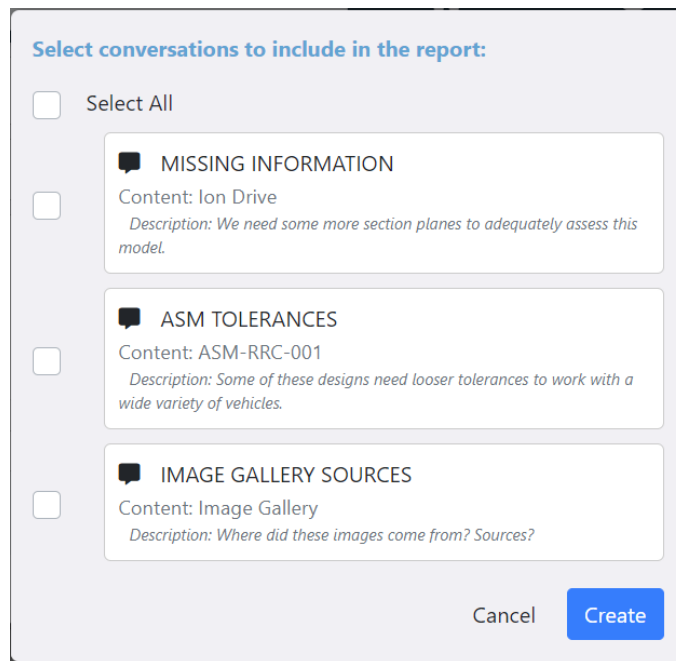
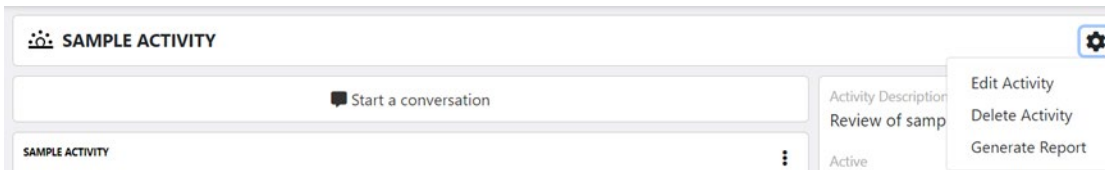

WORK ITEMS

WORK ITEM CREATION

There are three main avenues for creating a new work item: through the `Create` option in the navigation bar, through the new `Work Items` tab within an activity, or through a comment on a conversation in an activity.

To create a new work item from the navigation bar, first select the `Create` option, followed by the `Work Item` option in the drop-down menu.

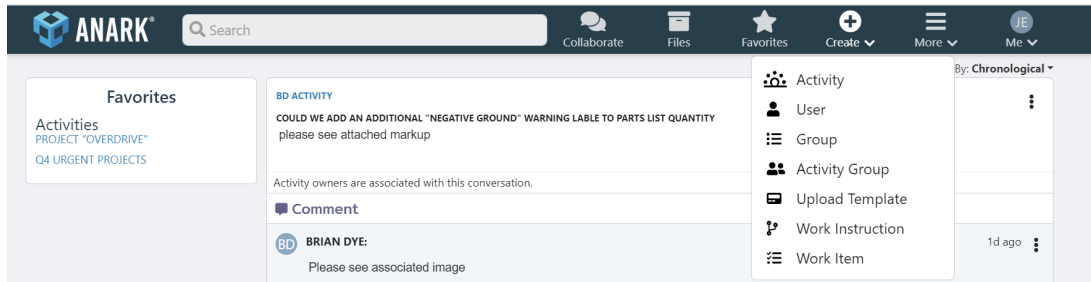

To create a work item from an activity, first navigate to the activity you want to associate the work item with and select the new `Work Items` tab in the upper righthand corner of the activity page. Next, select `Create a Work Item` and `Task`, `Review`, or `Issue` from the resulting drop down. This selection does not determine any of the attributes available on the work item.

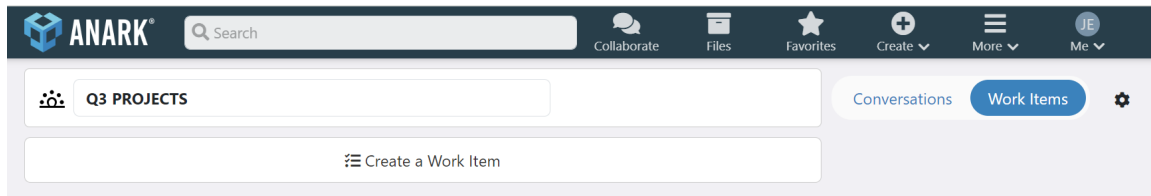

Finally, a work item can be created while drafting a comment. To do this, first navigate to an activity, create a conversation if necessary, and select `Comment` on the relevant conversation. Select `Work Item` located below the comment draft box and choose from `Task`, `Issue`, or `Review` as the work item type.

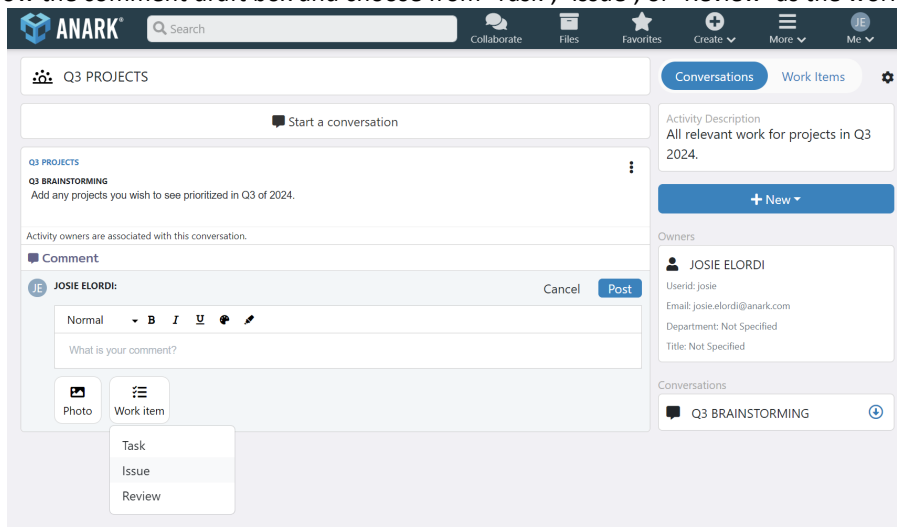

Anark Collaborate User Reference

Any creation path will result in the work item creation modal where you can give the new work item a title, description, assignee, due date, state, priority, and activity association. If the work item was created from an activity, the activity association field will be prepopulated with the current activity. In this modal, you can also change the type of work item through the dropdown menu in the upper right corner.

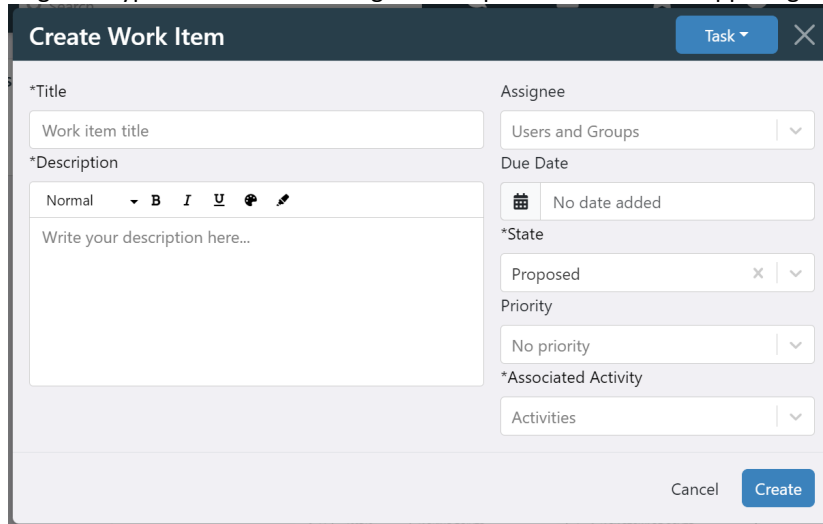

The 'Create Work Item' modal is a dark-themed window with a title bar containing a 'Task' dropdown and a close button. The main area is divided into two columns. The left column contains a '*Title' text input field, a '*Description' rich text editor with a toolbar (Normal, Bold, Italic, Underline, Bulleted List, Numbered List), and a 'Write your description here...' placeholder. The right column contains an 'Assignee' dropdown menu, a 'Due Date' calendar input field, a '*State' dropdown menu, a 'Priority' dropdown menu, and an '*Associated Activity' dropdown menu. At the bottom right, there are 'Cancel' and 'Create' buttons.

If you created this work item from a comment, the new work item will be linked to in that comment and the work item will contain a `Created In` field which links back to the originating comment.

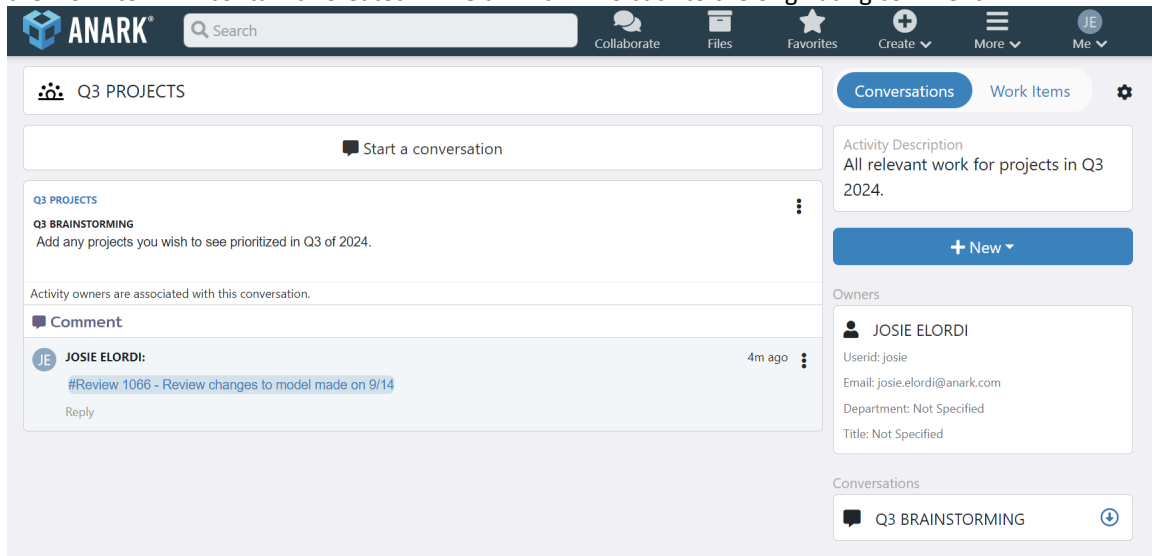

The screenshot shows the Anark Collaborate interface. At the top is a navigation bar with the Anark logo, a search bar, and icons for Collaborate, Files, Favorites, Create, More, and Me. Below the navigation bar is a header for 'Q3 PROJECTS' with tabs for 'Conversations' and 'Work Items'. The main content area shows a conversation titled 'Q3 BRAINSTORMING' with the description 'Add any projects you wish to see prioritized in Q3 of 2024.' A comment by 'JOSIE ELORDI' is visible, containing a link to '#Review 1066 - Review changes to model made on 9/14'. The right sidebar shows the 'Activity Description' as 'All relevant work for projects in Q3 2024.' and the 'Owners' section listing 'JOSIE ELORDI' with user details. At the bottom of the sidebar, there is a 'Conversations' section with a link to 'Q3 BRAINSTORMING'.



Anark Collaborate User Reference

WORK ITEM INFORMATION PAGE

Work items associated with an activity will appear in the `Work Items` tab within that activity with the work item most recently updated at the top of the list. To view all properties and discussion of a work item, select either the work item number on the work item card in the feed, or the title of the work item in the righthand sidebar.

From the work item page, the work item author, assignee and any admin can update the properties of the work item, e.g. they can move the work item from `Proposed` to `In Progress`, upgrade the priority from `Medium` to `High`, etc. After changing any of the work item properties, select `Save` to preserve those



changes and update the work item’s history. These users can also add content items and files to the work item. Members of the activity associated with the work item can leave comments and replies.

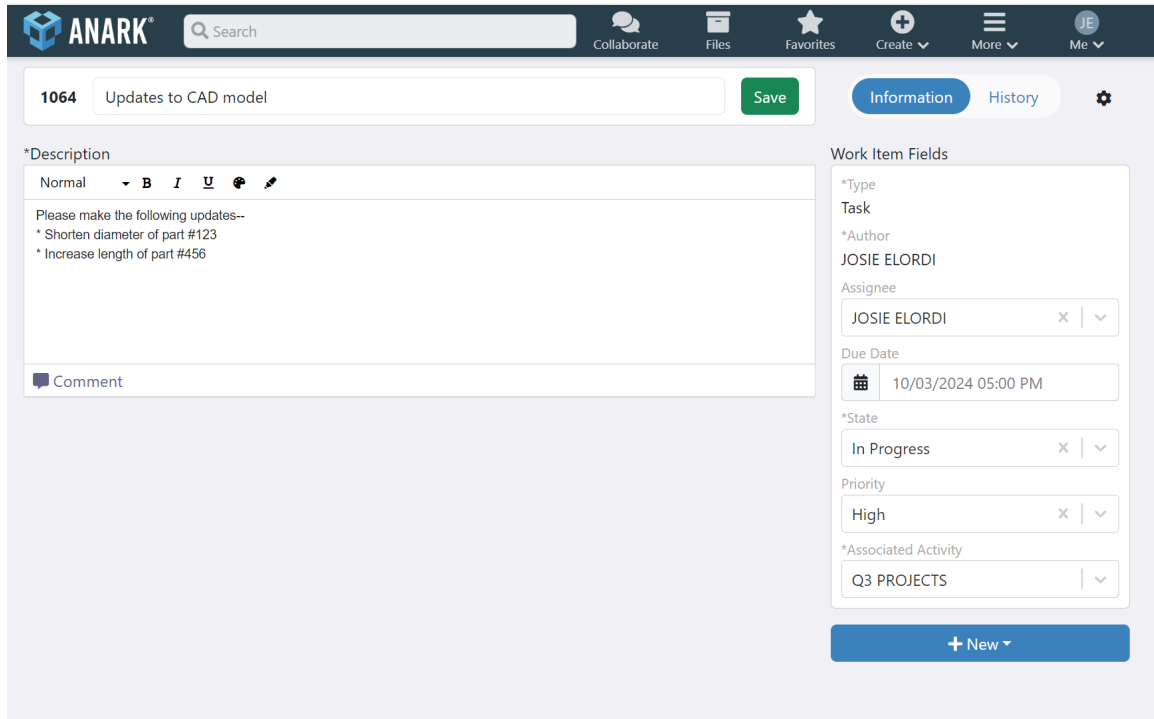

Work items can be deleted by the author of the work item or admin using the gear menu in the upper right corner of the work item page. From this menu, you can also favorite the work item which adds it to your `Favorites` menu in the `Collaborate` feed and the `Favorites` page accessed from the navigation bar.

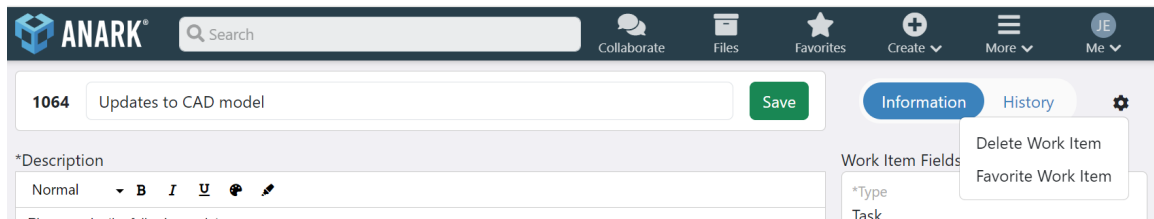

ADDING CONTENT ITEMS AND FILES TO A WORK ITEM

Work items contain their own set of content items and files. To add a content item to a work item, first navigate to the desired work item and select the `+ New` option in the righthand side bar. This same option and all dropdown menu options also exist in activities.



Anark Collaborate User Reference

1074 Update part no.123 Save

Information History

*Description

Normal B I U

Part no.123 needs to be increased in length. I will take this on.

Comment

Work Item Fields

*Type
Task

*Author
JOSIE ELORDI

Assignee
JOSIE ELORDI x | v

Due Date
09/27/2024 12:00 AM

*State
In Progress x | v

Priority
High x | v

*Associated Activity
Q4 PROJECTS

+ New v

- Upload A File
- Create a Folder
- Copy from My Files
- Add a Content Item

After selecting `Add a Content Item`, you will be prompted to select from a list of content items you have access to within Collaborate. Upon selection, content items are added to the righthand side bar.

1074 Update part no.123 Save

Information History

*Description

Normal B I U

Part no.123 needs to be increased in length. I will take this on.

Comment

Work Item Fields

*Type
Task

*Author
JOSIE ELORDI

Assignee
JOSIE ELORDI x | v

Due Date
09/27/2024 12:00 AM

*State
In Progress x | v

Priority
High x | v

*Associated Activity
Q4 PROJECTS

+ New v

Content Items

- AC_V6_TURBO_EN GINE_TESTING x
Document ID: Not Specified
Not Specified



WORK ITEM HISTORY PAGE

To view the history of changes made to a work item, select the 'History' tab in the upper right corner of the work item page. The history page contains a log of each batch of changes made to the work item. The first entry in a work item's history will always contain the properties set upon initial creation.

The screenshot displays the ANARK interface for a work item history page. At the top, there is a dark navigation bar with the ANARK logo, a search bar, and several utility icons: Collaborate, Files, Favorites, Create, More, and Me. Below the navigation bar, the work item title '1064 Updates to CAD model' is shown, along with 'Information' and 'History' tabs. The history log contains two entries, both by 'josie elordi'. The first entry shows a state change from 'Proposed' to 'In-progress' on 9/19/2024 at 11:53:53 AM. The second entry shows the task creation on 9/19/2024 at 11:48:26 AM. A detailed view of the task is provided below, listing fields such as Title ('Updates to CAD model'), Description ('Please make the following updates--* Shorten diameter of part #123* Increase length of part #456'), Type ('Task'), State ('Proposed'), Priority ('High'), Due Date ('10/3/2024 5:00:00 PM'), Associated Activity ('q3 projects'), and Assignee ('josie elordi').

SEARCH PAGE

The Search Bar is located at the top of every page in the navbar, but plays a different role depending on which page you are on. On the Search, Manage Activity, Manage Group, and Manage Work Instruction pages the search bar will expand, and search results will appear on the same page. On all other pages, the search bar will navigate the page to the Search page where it will display the results.

Collaborate page:

The screenshot shows the ANARK Collaborate page. The top navigation bar is consistent with the previous screenshot. Below the navigation bar, there is a 'Favorites' section. It displays a list of items, including 'GEOLOGICAL MAPPING OF PLANETARY BODIES' and 'MOON MAP DISCUSSION'. A 'Filter By: Chronological' dropdown is visible on the right side of the list.

Search Page:

The screenshot shows the ANARK Search Page. The top navigation bar is consistent with the previous screenshots. Below the navigation bar, there is a search bar and a list of search results categories: Content Items, Work Items, Activities, Users, Groups, Templates, and Activity Groups.

A search query can be constructed to lookup general keyword and specific starts with phrases. All keywords are implicitly search OR. For example, a search query of <blue pump> will search any indexed searched properties that contain "blue" or "pump". To augment this behavior you can include AND, OR, and parentheses () that support basic logic and order of operations. To search for full phrases, you can



wrap terms in quotes. A search for <"blue pump"> would search for index field that starts with the phrase "blue pump".

```
blue pump
"blue pump"
"blue pump" AND red
"blue pump" AND (red OR yellow)
```

Column names can be specified by using brackets. To search for only the name of a document the query would be <[name] = "blue pump"> A term should be surrounded by quotes in order to be included in the column search. Without quotes around "blue pump" it would query for where name equals blue or any keyword that matches pump.

```
[name] = "blue pump"
[description] = "high pressure"
```

Furthermore, a user can define wildcards to search for partial keywords. A * operator means 0 or more characters and a ? operator means any character, but exactly 1. For example, a search term of <[name] = blue*> will return results of any documents with names that start with the word blue

```
[name] = blue*
[description] = "high pressur?"
```

Custom sorting is supported, by default all search results show the most recently added items at the top. To change the order of the results you can specify <SORTASC [fieldName]> or <SORTDSC [fieldName]> to the end of any query.

```
[DocID] = 0013335B-* AND [Description] = "0013335B-12 ABC" SORTASC [name]
```









Characters used to define query parameters such as brackets, quotes, or parentheticals will be parsed as query syntax. To search for items with those special characters directly in the name insert a backslash before the character to treat it as plain text. For example, if document title contains the word "blue" (with quotes around it) you would need to search for the following to match the keyword.

```
\ "BLUE\"
```

CONTENT SEARCH

All users see the **Associated Activities**, **Mark as Favorite**, **Get Link**, and **Share** buttons within the sub-menu of each result. Users with Administrator or Content Author Roles will see a **Delete** button. Users with the Collaborator Role will see **Create Activity** which allows for quickly creating an activity with that content item. Clicking **Share** will open a modal to create an activity with that content and allow for inviting others to collaborate. If content is published with metadata, the content will be displayed in the search by name with the metadata below it.



-  Share
-  Delete
-  Archive
-  Mark as Favorite
-  Get Link
-  Create Activity
-  Associated Roles
-  Associated Activities
-  Associated Work Instructions

Clicking **Delete** will remove the Content from all Activities, Conversations, and Search Results for all users. Users will no longer be able to access deleted Content, but the content will still exist on the server. A flag is added to the Content on the server to indicate that it will be permanently deleted once every Activity that references the Content has been deleted. Conversations and Comments referencing the content will be maintained for archiving purposes, but no new Conversations or Comments can be created with the deleted content.

Clicking **Archive** will archive the content. Archived content is explained in more detail in [Content Archival](#).

Clicking **Associated Activities** will display a search result of all the Activities that that content is in regardless of whether the user is included in the Activity. If the user is not included in the Activity, they can open the Activity in a read-only mode, where they will not see any conversations or be able to add any comments.

Clicking **Associated Roles** will display all the roles that have access to the content item.

Clicking **Mark as Favorite** will add that content item to your list of favorites seen on the Collaborate page and on the Favorites page.

WORK INSTRUCTION SEARCH

Selecting the **Work Instructions** tab on the Search Page will display all Work Instructions that match the search criteria. Only Users with the View-Search-WorkInstruction role permission will be able to see the **Edit** or **Delete** buttons within the sub-menu of each result. Selecting a Work Instruction will redirect the user to that Work Instruction's Landing page.

Users with the Execute-WorkInstruction role permission will see additional buttons to execute the Work Instruction, Generate Execution Report, and view Associated Work Instruction Executions.

ACTIVITY SEARCH



Selecting the **Activities** tab on the Search Page will display all Activities that match the search criteria. Only Users with the Create-Update-Delete-Activity role permission will be able to see the **Edit** or **Delete** buttons on the search page. Selecting an Activity will redirect the user to that Activity's Landing page.

USER SEARCH

Selecting the **Users** tab on the Search Page will display all Users that match the search criteria. Only local users will have the option to edit or deactivate, and only Users with the Administrator Role will be able to see the **Edit** or **Deactivate** buttons below the user(s) shown on the search page. All users names will be displayed on the search page with the user's username and email address displayed below.

GROUP SEARCH

Selecting the **Groups** tab on the Search Page will display all Groups that match the search criteria. Only Users with the Administrator Role will be able to search for Groups.

ACTIVITY GROUPS SEARCH

Selecting the **Activity Groups** tab on the Search Page will display all activity groups that match the search criteria.

TEMPLATE SEARCH

Selecting the **Templates** tab on the Search Page will display all Templates that match the search criteria. **Edit** and **Delete** buttons are below each Template shown on the search page. Only Users with the Content Author Role will be able to search for Templates.



ANARK COLLABORATE USERS AND GROUPS

USER ROLES

Please refer to the Anark Collaborate Deployment documentation for details on Role Management.

USER CREATION

Anark Collaborate Administrators can create Anark Collaborate users by selecting the '+' **Create** button in the top right corner of any page then selecting **User** from the **Create** dropdown menu appears. On certain pages the **Create** button is in the **More** button.

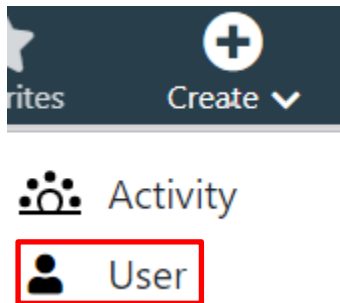

Once the **User** is selected, the page will navigate and a user creation form will appear. The Anark Collaborate Administrator must enter or select values for the required fields **Login Id, Password, Name, Email, and Roles**. All other fields are optional.

If Anark Collaborate is configured to have custom roles, those custom roles will appear as options when adding a user.

After values have been entered for all required fields, select **Create & Invite** to create the new user and invite them to Anark Collaborate. An email, from the Administrator that created the user and directed to the new user, will be generated to invite the new user to Anark Collaborate. The email will contain the user's **Username** and **Temporary Password**.



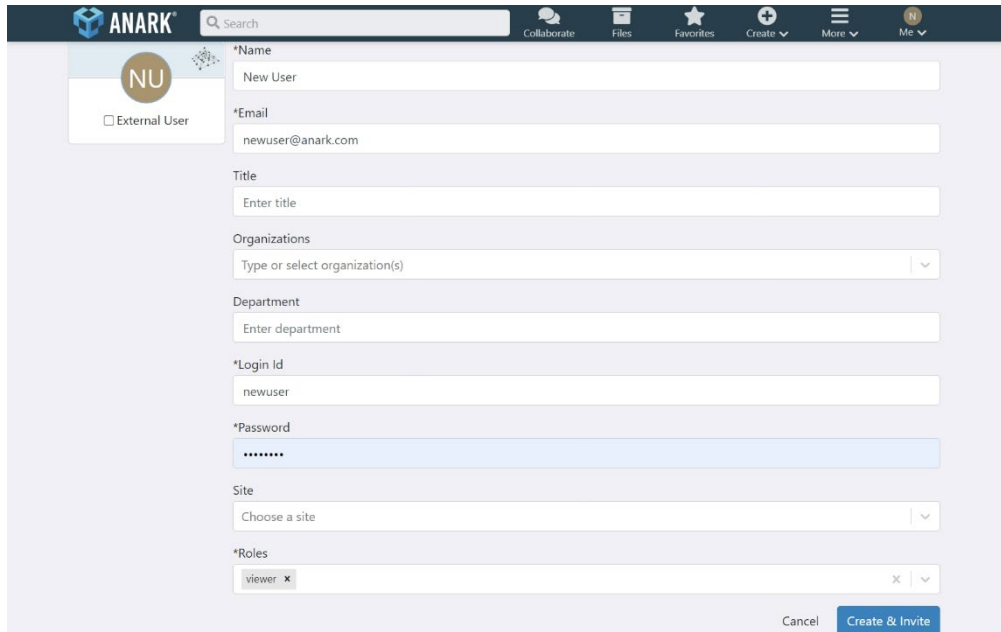

When adding users that will be managed from an external source, such as a PLM system, administrators can check the “External User” checkbox. This will grey-out the password field since the user’s credentials will be managed by the external source. **NOTE:** It is important that the “Login Id” matches the username of the external source.

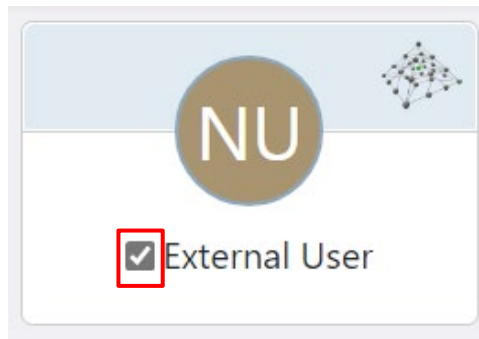

DEACTIVATING AND REACTIVATING ANARK COLLABORATE USERS

Anark Collaborate Administrators can deactivate and reactivate users by selecting **Deactivate** or **Activate** buttons below the user’s information on the Search Page. Please refer to [Search Page](#) and [User Search](#) on how to search for users to find these options. Selecting **Deactivate** will deactivate the Anark Collaborate user’s account and they will no longer be able to access Anark Collaborate until reactivated.

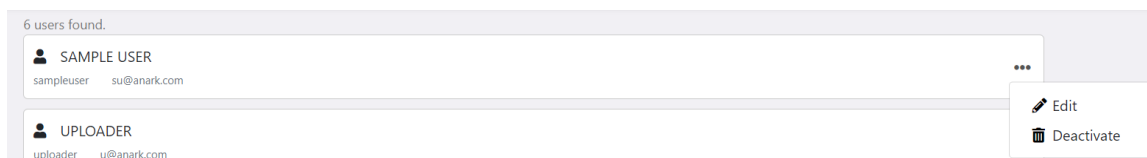

Anark Collaborate User Reference

Users that have been deactivated will have an **Inactive** flag under their name on the user search page. Anark Collaborate Administrators will still be able to edit inactive users by selecting the **Edit** button. Inactive users can be reactivated by selecting the **Activate** button.

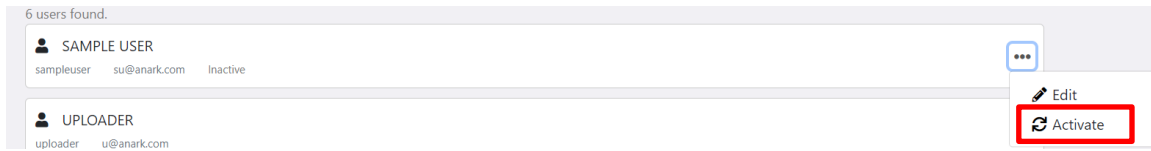

EDITING ANARK COLLABORATE USERS

Anark Collaborate Administrators can edit users by selecting the **Edit** button below the user's information on the Search Page. Please refer to [Search Page](#) and [User Search](#) on how to search for users to find these options. **NOTE:** External users can not be edited in Anark Collaborate and must be edited through the external system managing users.

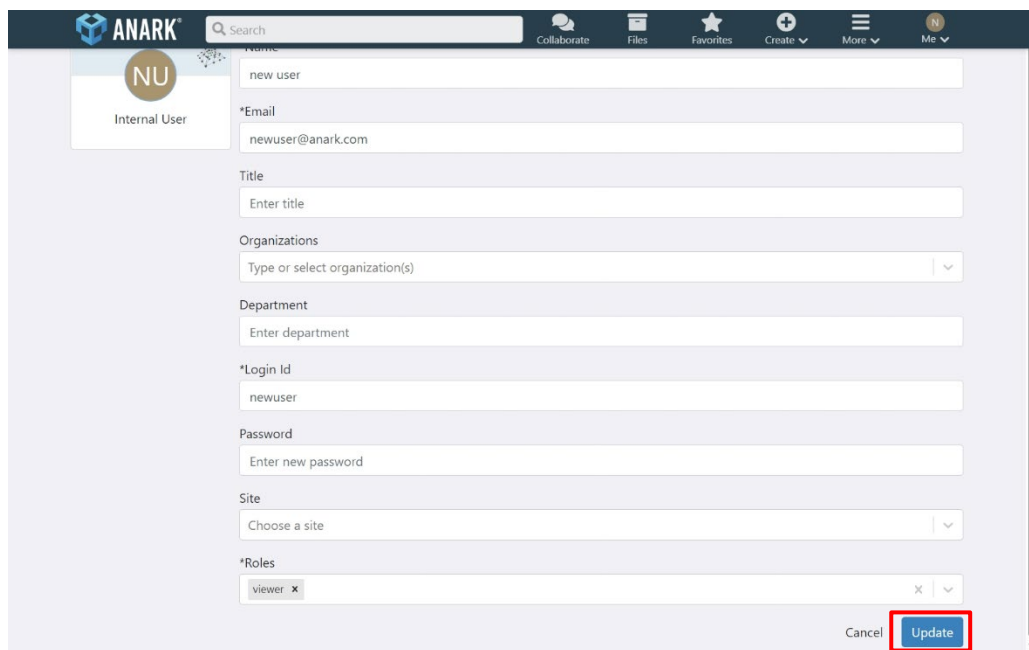

Selecting **Edit** will open the **Edit User** form. All the user's information can be managed from this page. Select **Update** to accept all changes or **Cancel** to exit out of the Edit User form without adding changes.

A screenshot of the "Edit User" form in the Anark Collaborate application. The form is titled "Internal User" and has a "NU" icon. It contains several input fields: "Name" (with "new user" entered), "*Email" (with "newuser@anark.com" entered), "Title" (with "Enter title" placeholder), "Organizations" (with "Type or select organization(s)" placeholder), "Department" (with "Enter department" placeholder), "*Login Id" (with "newuser" entered), "Password" (with "Enter new password" placeholder), "Site" (with "Choose a site" placeholder), and "*Roles" (with "viewer" selected). At the bottom right of the form, there are two buttons: "Cancel" and "Update". The "Update" button is highlighted with a red rectangular box.

CREATING GROUPS

Groups make roles management more efficient by assigning roles to sets of users instead of individual users. Administrators can create Groups by selecting the '+' **Create** icon in the top right corner of any



Anark Collaborate page then selecting **Group** from the **Create** dropdown menu. On certain pages the **Create** button may be located within the **More** button.

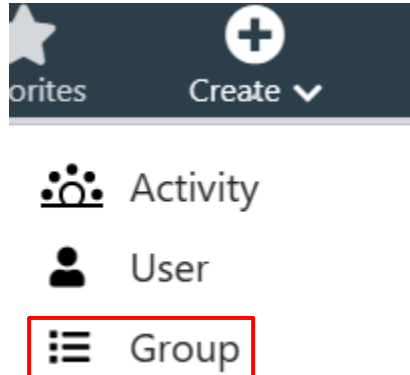

After **Create Group** is selected, the setup form will appear. The Administrator must enter or select values for **Name** and **Description**. **Members**, and **Roles** are optional but recommended. After values have been entered, select **Create** to finish creation of the group.

If Anark Collaborate is configured to have custom roles, those custom roles will appear as options when creating a group.

CONTENT ARCHIVAL

Anark Collaborate Users with the Content Author role can archive, or un-archive, published content. Archived content cannot be republished or updated. Additionally, only users with the Content Author role can search for archived content. Archived content cannot be added to activities or conversations; however, a conversation that was created before the content was archived, will still allow commenting and markups.



Anark Collaborate User Reference

All archived content will show an **Archived** indicator next to the content title.

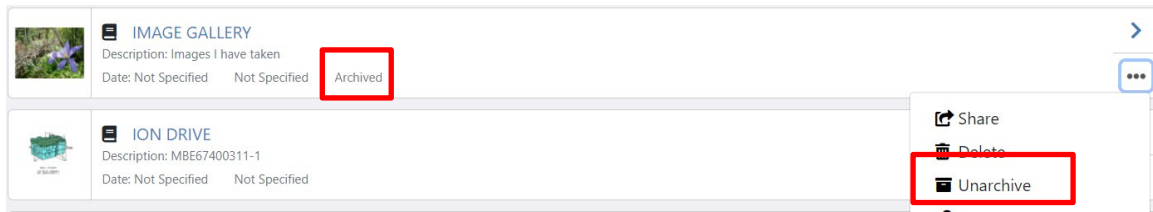

VIEWABLE CONTENT

Anark Collaborate supports viewing many content types directly in any browser; however, there are a few types that cannot be viewed yet. For this rare case, attempting to view a non-viewable content will instead prompt Users to download the content to their device.



TEMPLATE UPLOADING

Anark Collaborate Users with the Content Author role can upload templates that can be used when publishing content to Anark Collaborate from Anark Publish. To upload a template, select the '+' **Create** icon in the top right corner of the screen and then select **Upload Template** from the **Create** dropdown menu. On certain pages the **Create** button is in the **More** button.

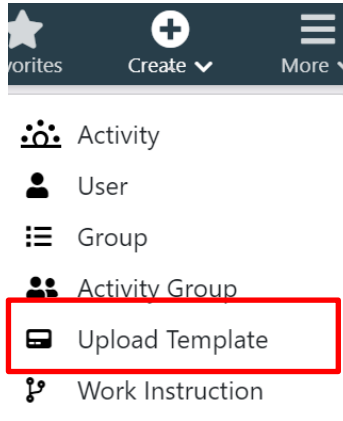

After **Upload Template** is selected, the upload form will appear. The user must choose a ZIP file that contains the template intended for use. Once ready, select **Upload** to upload the template. Once the upload is complete, Anark Workstation and Anark Publish will be able to see the template as an available option during content publishing.

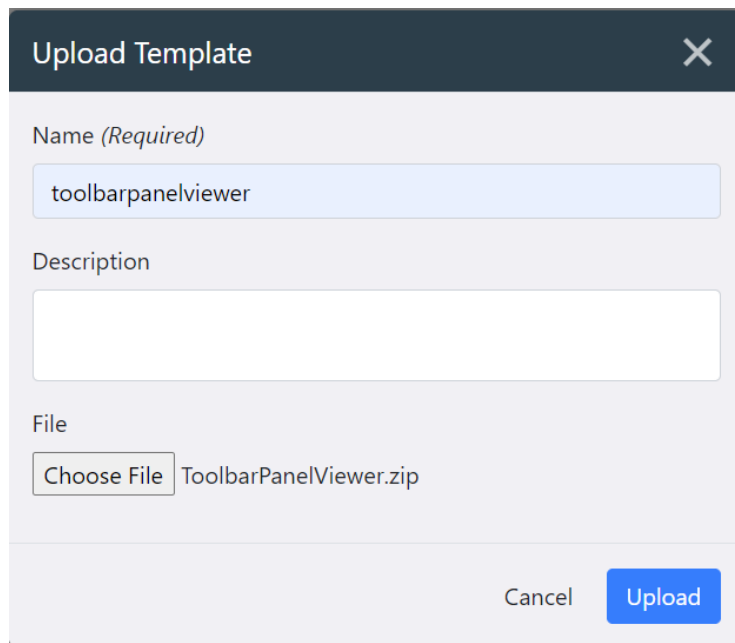
A screenshot of a 'Upload Template' dialog box. The dialog has a title bar with 'Upload Template' and a close button. It contains three input fields: 'Name (Required)' with the text 'toolbarpanelviewer', 'Description' (empty), and 'File' with a 'Choose File' button and the text 'ToolbarPanelViewer.zip'. At the bottom right, there are 'Cancel' and 'Upload' buttons.

FIELDS

- **Name:** The chosen template name will be used when searching for templates within Anark Workstation or Anark Publish.
- **Description:** An optional field to provide more information about the template.
- **File:** A zipped file containing the template files. The zip must contain either a `template.config.json` template definition, or all three `template.config.js`, `index.html`, and `config.js` files.

Once a template is uploaded, users with Content Author role can search and edit templates which uses the same UI as above.

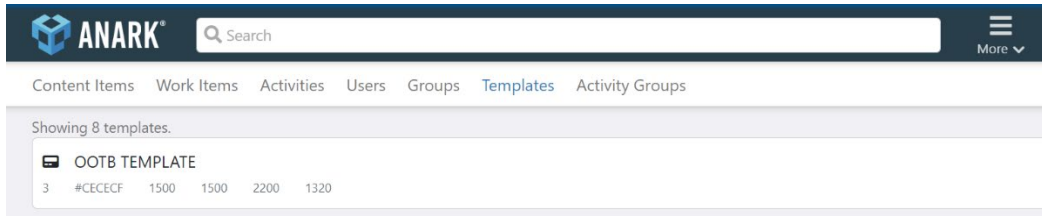

ACTIVITY GROUPS

ACTIVITY GROUP CREATION

Anark Collaborate Users with the Administrator Role can create Activity Groups. Activity Groups control who can participate in Activities and Conversations. To create an Activity Group, select the '+' **Create** icon in the top right corner of the screen and then select **Create Activity Group** from the **Create** dropdown menu. On certain pages the **Create** button is in the **More** button.

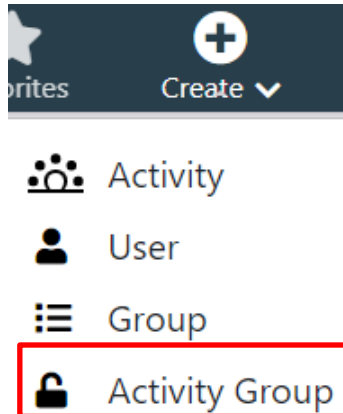

After selecting **Activity Group**, a modal will appear. Values must be entered in the **Title**, **Description**, and **Members** fields. To add members, type their name into the “Users” field and select the appropriate User from the dropdown.

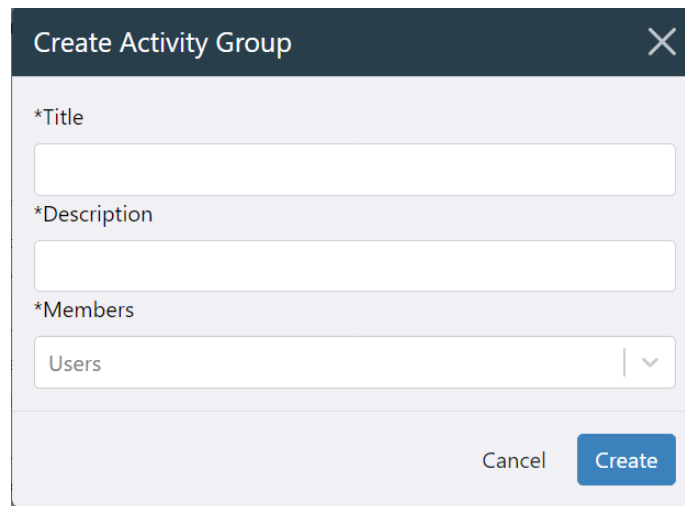
A screenshot of a modal window titled 'Create Activity Group' with a close button (X) in the top right corner. The modal contains three required fields: '*Title' with an empty text input, '*Description' with an empty text input, and '*Members' with a dropdown menu showing 'Users' and a downward arrow. At the bottom right of the modal, there are two buttons: a grey 'Cancel' button and a blue 'Create' button.

The user must select the blue **Create** button on the bottom-right to finalize creation of the new Activity Group. The new Activity Group can now be added to Activities and Conversations.



EDITING AND DELETING AN ACTIVITY GROUP

From the search results, Administrators can edit or permanently delete any Activity Group by selecting the ellipsis on the right of the result and selecting **Delete** or **Edit**.

Selecting **Delete** will mark the Activity Group as inactive in the system. An inactive status means no one will be able to add that group to an **Activity** nor will the group be searchable. The group will be permanently deleted from the system once all **Activities** that included that activity group have been deleted. If the activity group was not participating in any activities at time of deletion, then it will be immediately and permanently deleted. Deleting the activity group will not delete any members of the group.



CONVERSATIONS

CREATING NEW CONVERSATIONS

Any user participating in an Activity can create a Conversation in that Activity. This includes Activity Owners, Users, and members of Groups. Conversations can be created between any participant(s) and will lists all conversation participants below the title. Activity Owners will be able to see all conversations regardless of who created it. Additionally, Activity Owners can create a conversation strictly between other Activity Owners. Those not included in the conversation will not see it in their feed.

To Create a new conversation the user will need to go to the desired Activity's landing page and select **Start a Conversation** to bring up the **New Conversation** dialog. The user needs only to enter a **Title**; all other fields are optional. One or more Activity Groups and/or users can be added to conversations. When all required fields contain values, press the **Create** button to create the Conversation. Comments and Conversations will simultaneously update on both the **Activity Page Newsfeed** and **Collaborate Newsfeed**.

Conversation descriptions support **rich text**, for further information on rich text support please refer to [Rich Text](#).

EDITING CONVERSATIONS

Activity Owners can edit any Conversation within an Activity they own. All users, included in an **Activity**, can edit Conversations they created. Select the 3 vertical dots on the right-hand side of the Conversation pane to reveal options to **Delete Conversation** and **Edit Conversation**.

Select **Edit Conversation** and the conversation will become editable. Select the **Update** button to finalize all changes after edits have been made. All edits will automatically update on the correct Activity Landing Page Newsfeed and the Collaborate Newsfeed for all users.

DELETING CONVERSATIONS

Activity Owners can permanently delete any Conversation within an Activity they own. All users included in an **Activity** can delete a Conversation they created. To delete a conversation, select the 3 vertical dots on the right-hand side of the Conversation pane. Options to **Delete Conversation** and **Edit Conversation**



will be shown. Select **Delete Conversation** to permanently delete the Conversation. The Conversation will be removed from the Activity Landing Page Newsfeed and the Collaborate Newsfeed for all users.

PRIVATE CONVERSATIONS

Conversations can be marked as *Private* either during creation or editing. If a conversation is private only the conversation owner can see the conversation in their feed. Additionally, only the conversation owner can comment and add markups. Users and Groups that are added to the conversation will not receive email notifications while the conversation is private but will receive an email notification when the privacy setting is changed. Private conversations will not be included in Activity Reports.

COMMENTS AND REPLIES

CREATING COMMENTS

Add comments to Conversations by selecting the **Comment** button at the bottom of the Conversation pane. Selecting the **Comment** button opens a text field with three additional options to add contextual information to your comment. **Photo** will always be available and allows users to upload a photo. This could be from their tablet or a picture on their computer. **Markup** will allow users to select a content item or file included in the activity, and add markup to it. Only items with markup-able components will be available to select. **Bookmark** allows users to save a position or view within the component of a content item or file. At this time, only one can be added to a comment, but all are optional. A comment posted without any text input will have "Please see associated image" text automatically added to the comment.

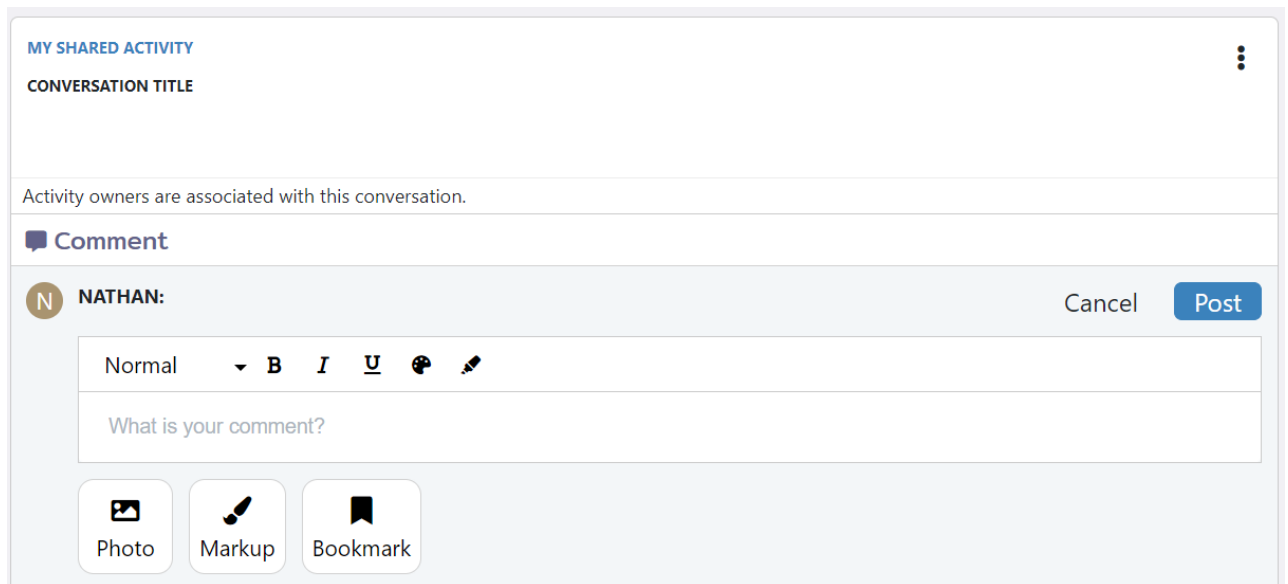

The screenshot shows a user interface for creating a comment. At the top, it says "MY SHARED ACTIVITY" and "CONVERSATION TITLE". Below that, a note states "Activity owners are associated with this conversation." The main section is titled "Comment" and features a user profile for "NATHAN:" with a "Cancel" button and a "Post" button. A rich text editor is present with a toolbar containing "Normal", "B", "I", "U", a globe icon, and a pencil icon. The text input field contains the placeholder "What is your comment?". At the bottom, there are three buttons: "Photo", "Markup", and "Bookmark".

RICH TEXT

Comments and Conversation descriptions support rich text. When creating or editing either of these you will be presented with a text box that has controls for styling your text.



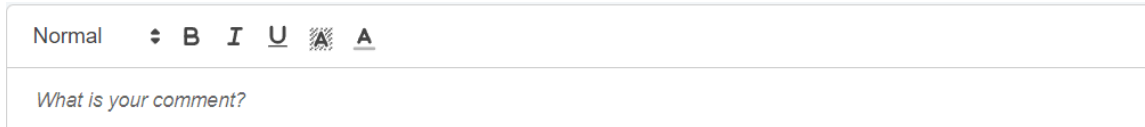

For styling you are given six different options to choose from.

Normal  **Font Size** – Lets you select font size, you can choose from small, medium, and large.

B **Bold** – Lets you bold text.

I **Italicize** – Lets you italicize text.

U **Underline** – Lets you underline text.

 **Background Color** – Lets you select the background color of text.

 **Font Color** – Lets you select the font color of text.

Alongside styling, comments and conversations descriptions have support for mentions.

MENTIONS

Mentions can be used to tag and notify specific users about your changes. To mention someone while creating/editing a comment or conversation, type @ and the user’s name or email address.

From a conversation, users will have the ability to mention any user, owner, or group participating in the activity. Additionally, a reserved @activity mention is available for conversations to mention all participants of the activity. Anyone not already included in the conversation will automatically be added to the conversation.

From a comment, users will have the ability to mention any user or group included in the parent conversation. Additionally, a reserved @conversation mention is available for comments to mention all participants of the conversation.

Mentions will bypass any global email preferences and only send an email notification to the tagged user or group. If a user has disabled email notifications under their personal account preferences, email notification settings will not be bypassed. For example, if new comment creation emails are disabled but a user is tagged in a comment, that user will receive an email notification. If that same user has email notifications disabled, they will not receive an email even if they were mentioned. If new comment



creation emails are enabled but a user is tagged in a comment, only the tagged user will receive an email notification instead of all users participating in the conversation.

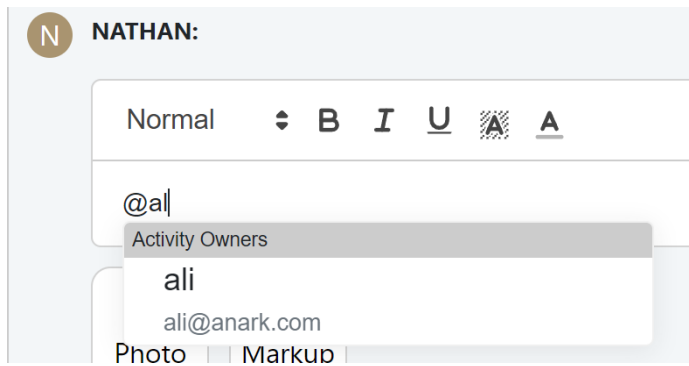
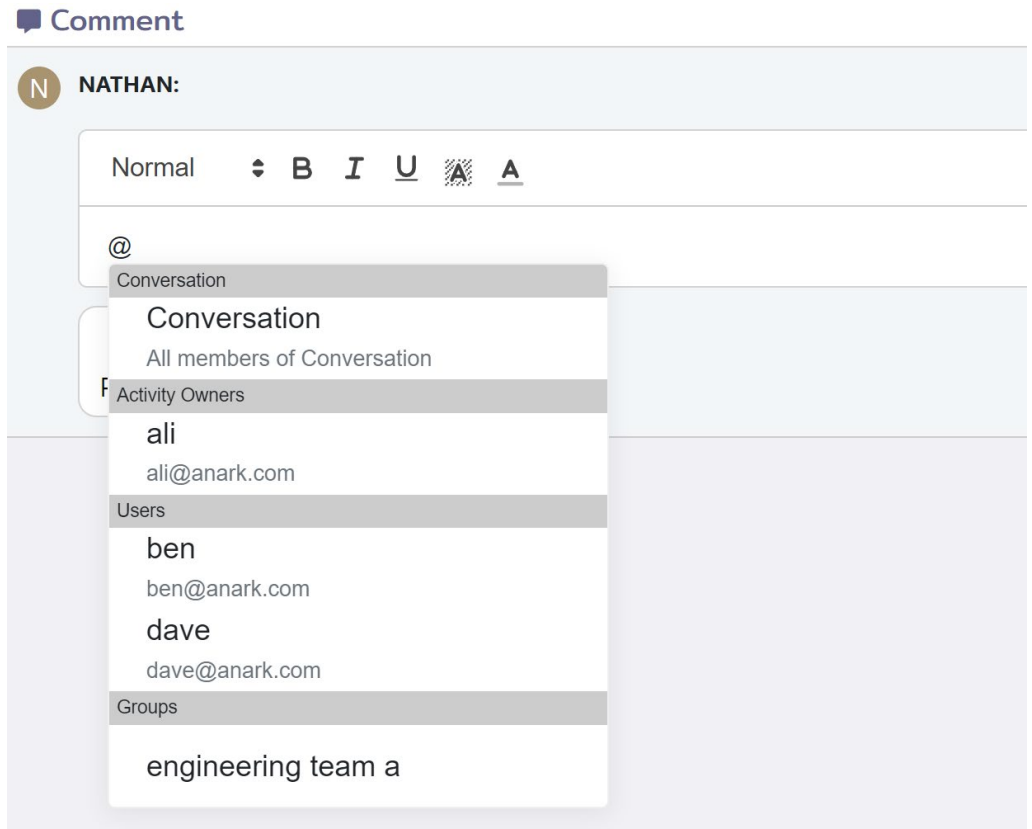

ADDING CONTEXTUAL INFORMATION TO COMMENTS

Additional information that may help in understand the context of a comment, can be captured from a content item or file with or without markup, can be uploaded from a device, or pasted (ctrl + v) from a clipboard screenshot. This information will be displayed as an image, screenshot, below the comment



text; however, upon clicking on the image it will open up to the component for full interactions and context. If uploading an image, markup can be applied after the upload.

When the content item or file is open in the modal, a Markup button will appear on the top right of the modal.

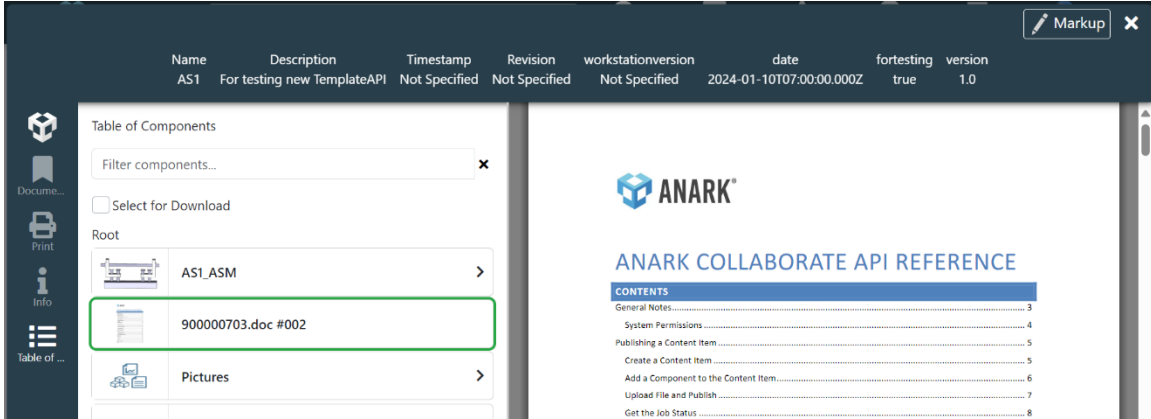



Selecting the **Markup** button will hide all widgets and the navbar and expose markup tools that can be used to better communicate project ideas to engineers, suppliers, manufacturers, etc. Saving the markup will create a 2D representation of the current view state with markups. To cancel capturing markup, click the **Cancel**  icon.

MARKUP TOOLS

While adding markup you can zoom in/out and pan to help apply markup precisely where you intend and not elsewhere. If multiple views (secondary canvas) or multiple content are visible at the same time, markups can be applied to any one at a time.

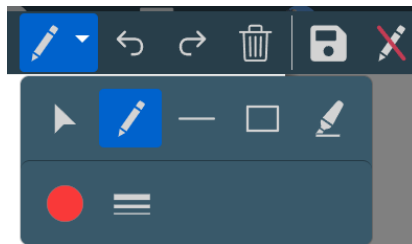







Markups can be applied to Data, Document, Image, and Model components. Each component type may have a different set of tools, either drawing or semantic.



 **Select** – Used to select a markup to allow for editing.

 **Free Draw** – Creates free drawn lines with a pen.



-  **Line** – Creates straight lines between the starting and ending points of a mouse drag. Has an option to add an arrowhead at the end of the line.
-  **Rectangle** – Creates corner to corner rectangles between the starting and ending points of a mouse drag.
-  **Text Highlight** – Enables highlighting text in a document or data component.
-  **Color Selector** – Provides menu to change to 1 of 9 available colors
-  **Line Weight**—Opens a sliding bar that can adjust line thickness or font size
-  **Undo/Redo buttons**—Undo and redo previous Markup actions in chronological order
-  **Save Markup**—Saves image (with or without Markup) and returns to the comment
-  **Cancel Markup** – Cancels any markup changes

Each markup type will additionally give users the option to add an annotation next to the markup. Clicking on the orange pin will open a dialog box for the annotation. To add another markup, you must minimize the dialog box first.

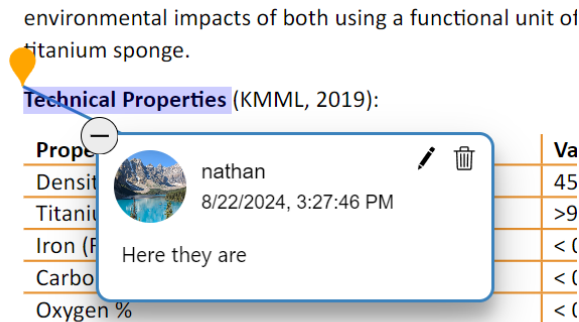

Select the **Save Markup** button on the Markup Toolbar to add the image and markup to the comment. The live content window will close and the new comment image will be shown. Press the **Post** button above the comment text box to post the comment.



JS JOHN SMITH: Cancel **Post**

Normal **B** **I** U  **A**

What is your comment?

ITEM NO.	Number	DESCRIPTION	Default/QUANTITY
1	RRC-013-W	Strut Spacer - Thick	16
2	RRC-013-W	Strut Spacer - Thin	12
3	RRC-023	Large Rivet	2
4	RRC-023	Large Rivet	2
5	RRC-023	Large Rivet	2
6	RRC-023	Large Rivet	2
7	RRC-023	Large Rivet	4
8	RRC-023	Large Rivet	4
9	RRC-023	Large Rivet	4
10	ASPA-RRC-002L	Roof Runner Assembly - Right	1
11	ASPA-RRC-002R	Roof Runner Assembly - Left	1
12	ASPA-RRC-002S	Strut Assembly	4
13	RRC-007	Link Intermediate Bar	4
14	ASPA-RRC-003	Large Rivet Strut Assembly	2
15	RRC-020	Large Rivet Hooks	4
16	RRC-021	Roof Runner Strap	4
17	LC3207433	Loading Gas Strut	2
18	ASPA-RRC-005	Roof Runner Assembly - Left	1
19	ASPA-RRC-005	Roof Runner Assembly - Right	1
20	RRC-04435	5/16" x 3/16" Hex Nut	8
21	RRC-100	1/4" x 3/8" Hex Washer	8

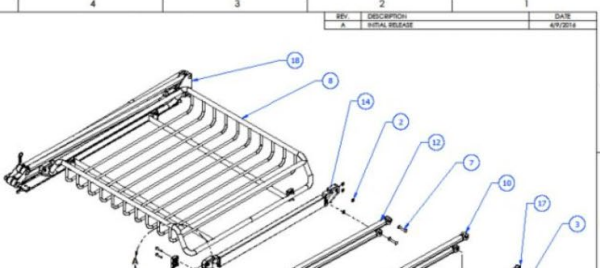

Users that have access to the activity if inheritance is enabled, or the content item if not, will have access to the markup. Clicking on the markup image will open the markup.

REPLYING TO COMMENTS

Anark Collaborate Users may reply to Comments using the **Reply** button beneath a comment, bringing up the same text field and Markup button as a new Comment. To maintain context of the Conversation's Comment, clicking **Reply** will automatically add the parent's Markup image to the reply.



JS JOHN SMITH:

1m ago

What are the radii on these curves?

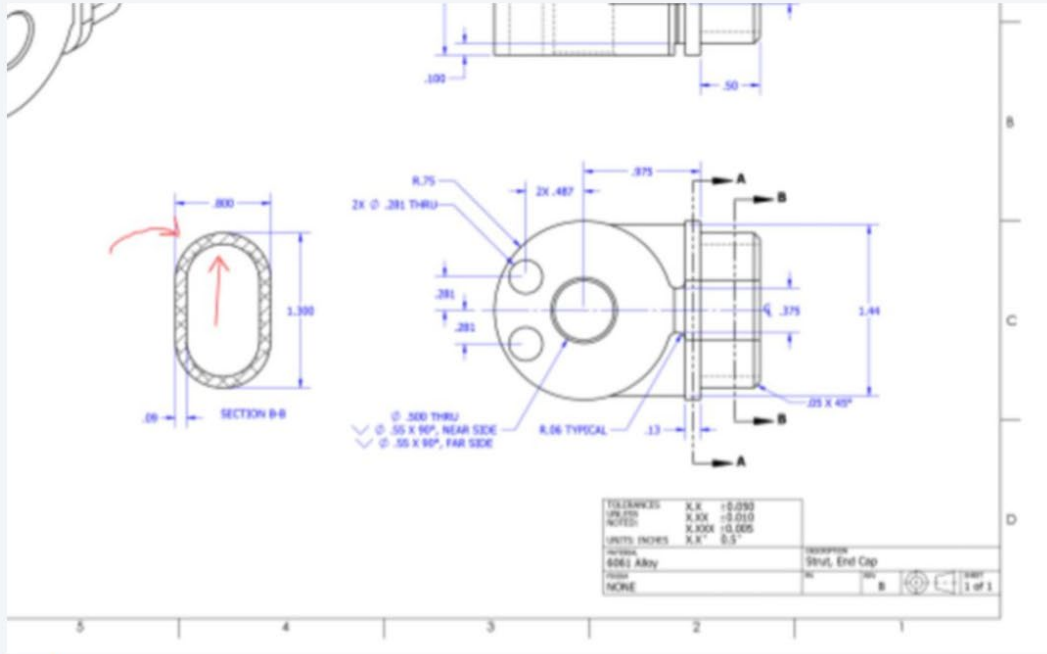

Reply

JS JOHN SMITH:

Cancel

Post

Normal **B** **I** **U** **A** **A**

What is your comment?

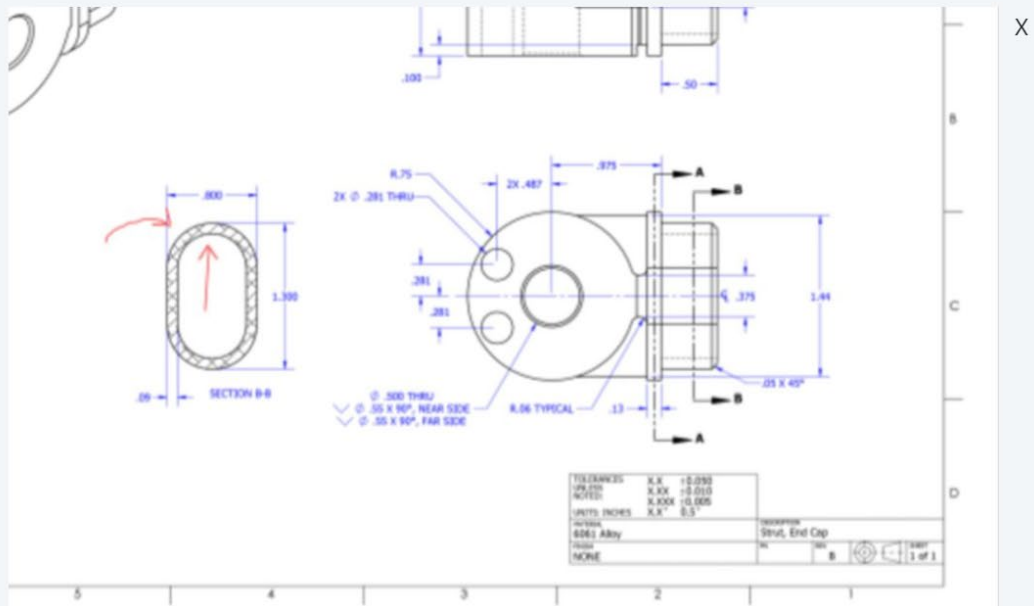

EDITING AND DELETING COMMENTS AND REPLIES

Users can edit comments and replies that they created, and Activity Owners can delete any comment or reply inside of an Activity they own by selecting the three vertical dots next to a comment/reply. The three vertical dots will reveal options to **Delete Comment** and **Edit Comment**. Selecting **Delete Comment** will permanently delete the comment. The comment will be removed from all users' Collaborate Newsfeeds and Activity Landing Page Newsfeeds.

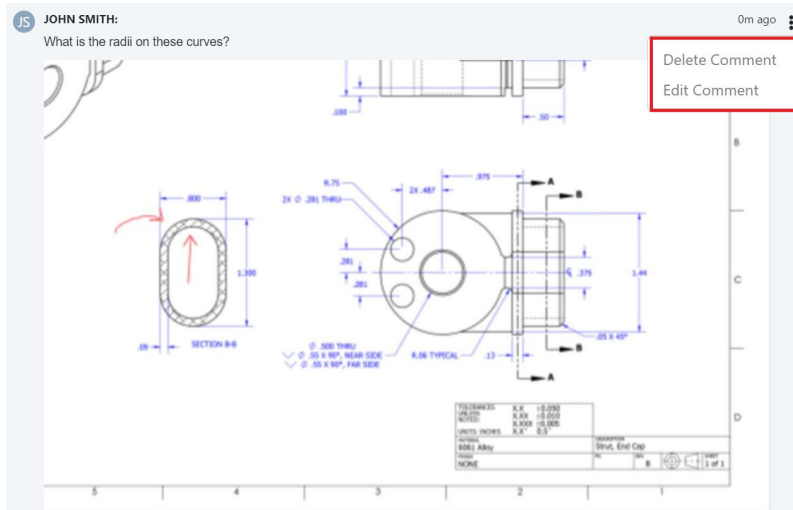

Selecting **Edit Comment** will allow users to edit the text and markup contained in a comment/reply or change the current markup to a different image. The markup can be removed from a comment/reply by selecting the 'X' next to the image. Select the **Update** button to accept all edits or press **Cancel** to restore the comment to the state it was in before pressing **Edit Comment**.

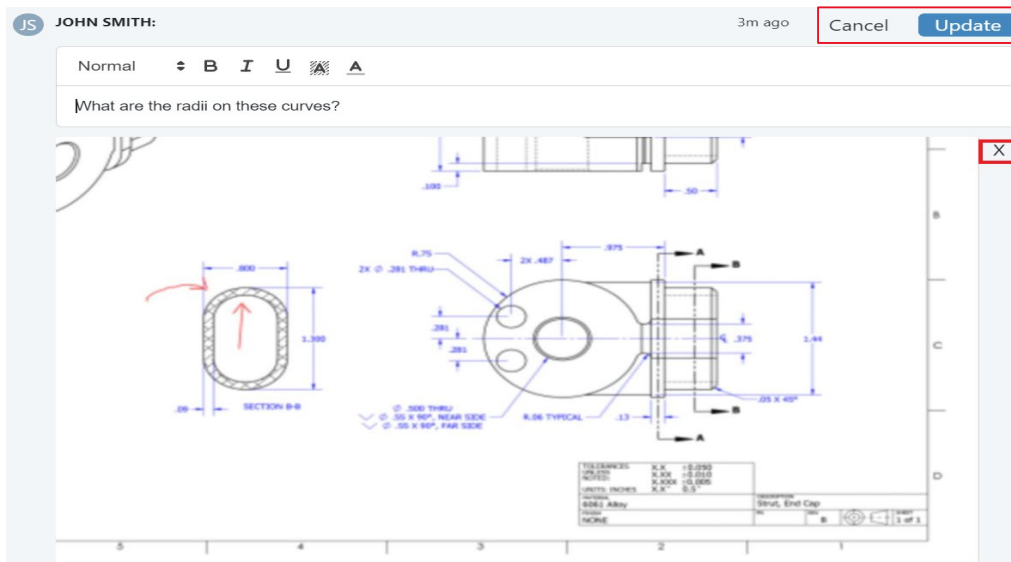

It is possible to add new or remove old markup by clicking on the image. This will open the same markup tools and your image. All the tools have the same functionality as described above. Additionally, the image can be zoomed and pan to see markups in more detail.



POP-UP CALLOUTS

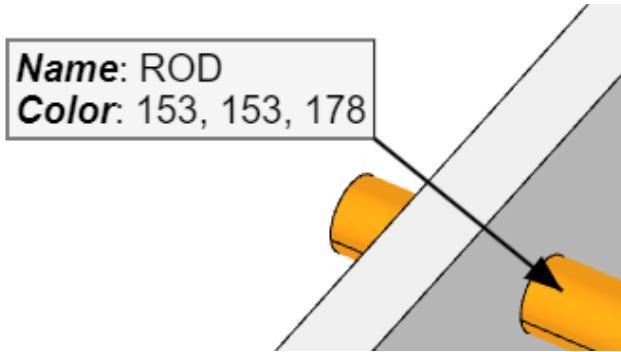

Pop-up callouts enable a user to quickly inspect CAD attributes in Anark Collaborate with a click. When enabled, selecting an occurrence in the 3D view will result in a leader style callout – displaying a configurable (on publish) set of attribute keys and values, linked to the occurrence and 3D location clicked. These can be moved around by left-clicking the text area and dragging. The leader or arrow will update with the view as the user zooms, pans, and rotates. Linked 3D arrow locations can be reset with subsequent clicks on the selected occurrence.

CONFIGURATION

PUBLISH

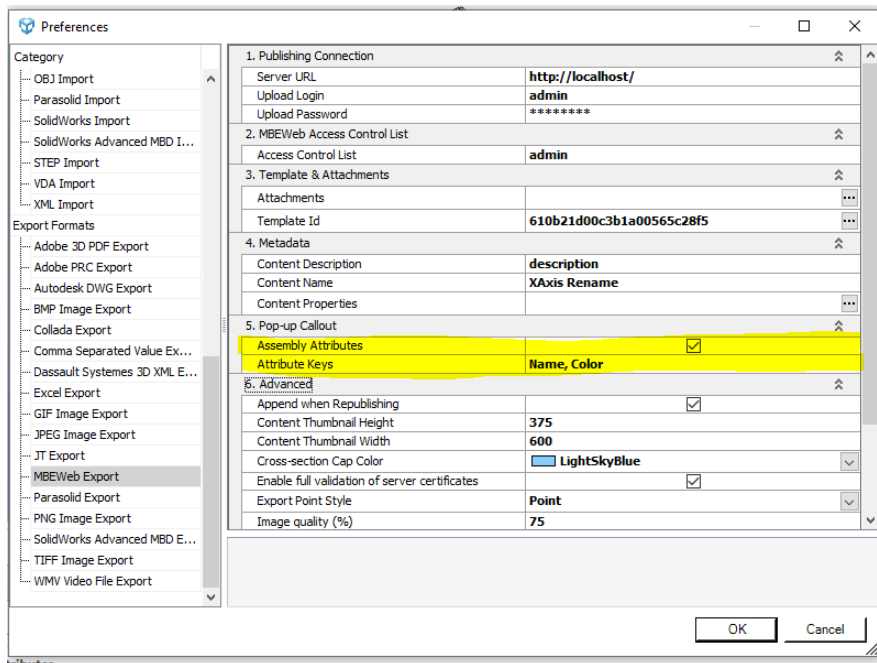

There are two places in Anark Workstation where pop-up callout attributes can be set for publish. The first is within the Anark Collaborate Export section of the preferences dialog.



Anark Collaborate User Reference

Content Description: description

Custom: [Empty field]

Get Schema

Advanced

- Append when Republishing
- Enable full validation of server certificates (recommended)
- Server communication timeout (seconds): 3600
- Cross-section cap color: #FF87CEFA Use part occurrence colors for cross section caps
- Minimum GLTF packet size (KB): 100
- Image quality (%): 75
- Point Font: Point
- Pop-up Callout Attribute Keys: Name, Color
- Pop-up Callout Assembly Option:
- X-Axis Label: X-Axis
- Y-Axis Label: Y
- Z-Axis Label: Z

Save these settings

Publish Cancel

The second is within the publish dialog when a user clicks “Publish to Anark Collaborate” from the File menu. Here, there is an option to save these settings for future use within global preferences.

Transformation Inspector

Query Reorganize Attributes Simplify Process

Apply

Component	Value
Connector: Standard Attributes	
Name	ROD
Color	255,153,153,178

The “Attribute Keys” field is a comma separated list of CAD attributes requested to be shown in all pop-up callouts. These keys will be referenced within the published data – determining the pop-up callout contents across the entire drawing. If the selected occurrence in Anark Collaborate contains none of the requested attribute keys, no callout will be shown. If a subset of attribute keys is found, those keys will be shown. And all attributes will be displayed in the order of this attribute keys list. For example, if one wanted “Color” to be displayed above “Name” in the pop-up callout, setting “Attribute Keys” to “Color, Name” would accomplish this.

The “Assembly Attributes” option is a Boolean field, enabling pop-up callouts to traverse upwards to the assembly definition of a selected occurrence for attributes. For example, if a selected occurrence did not have “Color” defined in its attributes, however, its assembly did, setting “Assembly Attributes” to true would allow the pop-up callout to display “Color”. If false, the attribute would not be displayed.

Pop-up callout preferences can be overwritten in recipe when publishing content using Anark Publish.



TEMPLATE API

To enable the pop-up callout feature, the pop-up callout button needs to be set as visible in the template. By default, the button and pop-up callout features are disabled and not visible. Once enabled, a user within Anark Collaborate can toggle the visibility of pop-up callouts by clicking the button found in the upper right corner of the 3D view.

showPopupCalloutButton

Type: boolean

A flag that determines whether or not the Popup Callout Button will be displayed.

Default Value:

- false

Example

Showing the toggle button.

```
templateConfig = {  
  cadWidgetOptions: {  
    cadCanvasOptions: {  
      showPopupCalloutButton: true  
    }  
  }  
};
```

VIEWING CALLOUTS IN ANARK COLLABORATE

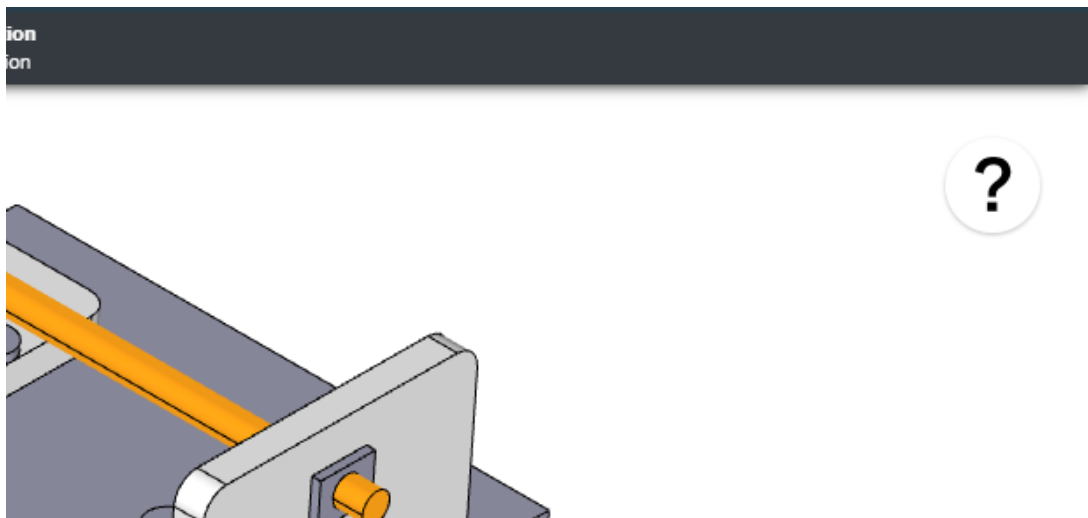

A black question mark indicates that the pop-up callout features are toggled off (not visible). In this state, selecting occurrences within the drawing will not result in pop-up callouts being shown.



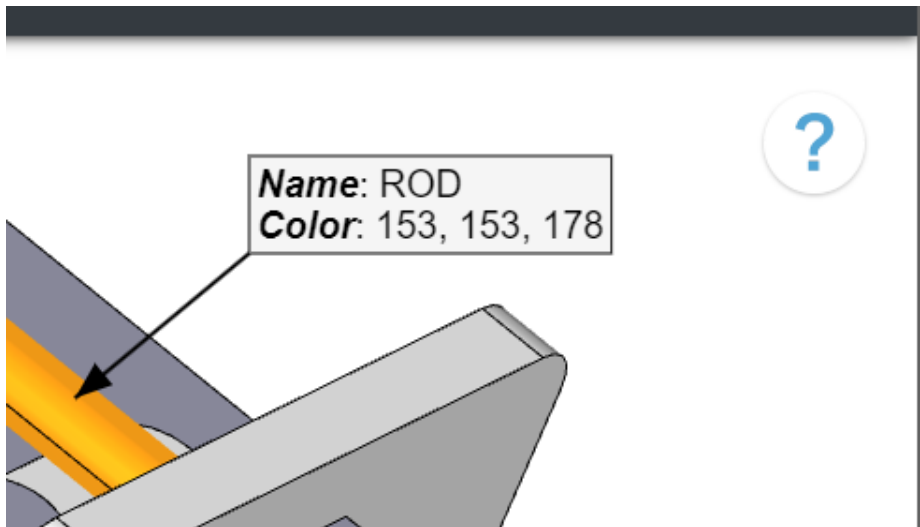

Left-clicking the black question mark will enable pop-up callouts. If there is currently a selection, a pop-up callout will be shown if the requested attribute keys are found. Otherwise, any selections made in this state will be searched for the requested attribute keys and a pop-up callout shown if found. When a selection does not exist, all pop-up callouts will disappear.

Pop-up callouts also work during animations. If a user selects an occurrence while animating, the animation will be paused, and the selection will be searched for pop-up callout attributes. When played, all visible pop-up callouts will be hidden.



3D AXIS

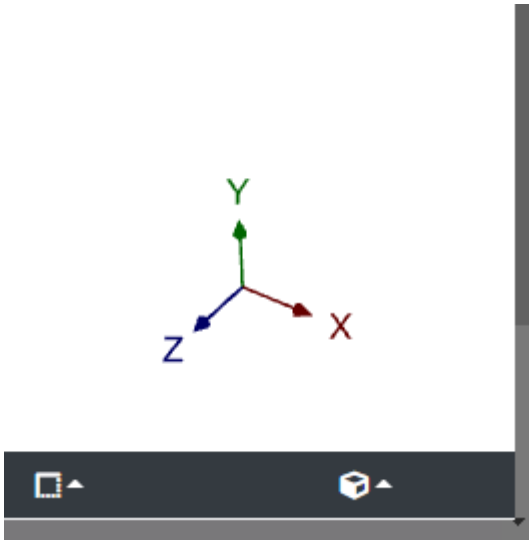

A 3D axis is displayed in the lower right corner of the model view. A user can then tell the orientation of the model with respect to the view. As the view is rotated, the orientation of the axis is updated to reflect the model's orientation. Axis labels are modifiable during the publish step to Anark Collaborate.

CONFIGURATION

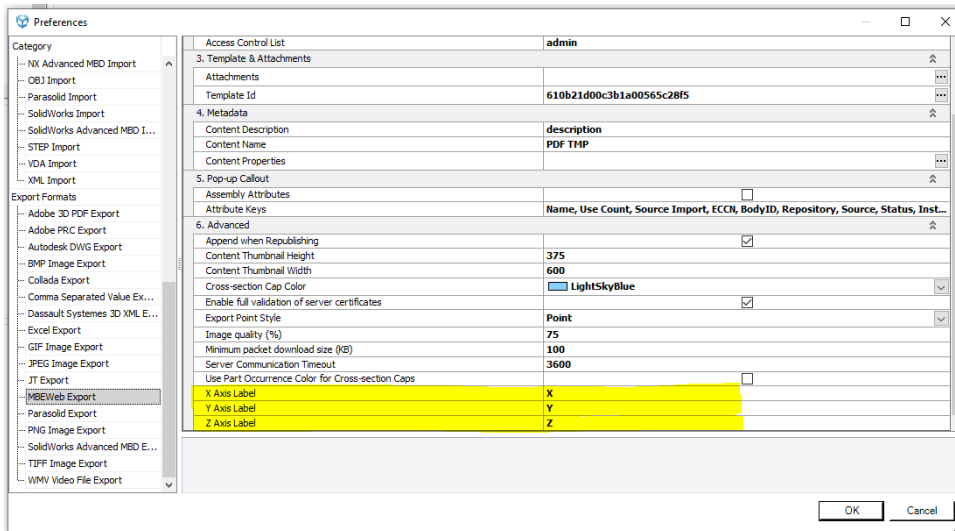

There are two locations within Anark Workstation where a user can modify the axis labels. The first is within the Anark Collaborate Export section of preferences. Here, one can individually assign labels for the X, Y, and Z directions of the axis.



Anark Collaborate User Reference

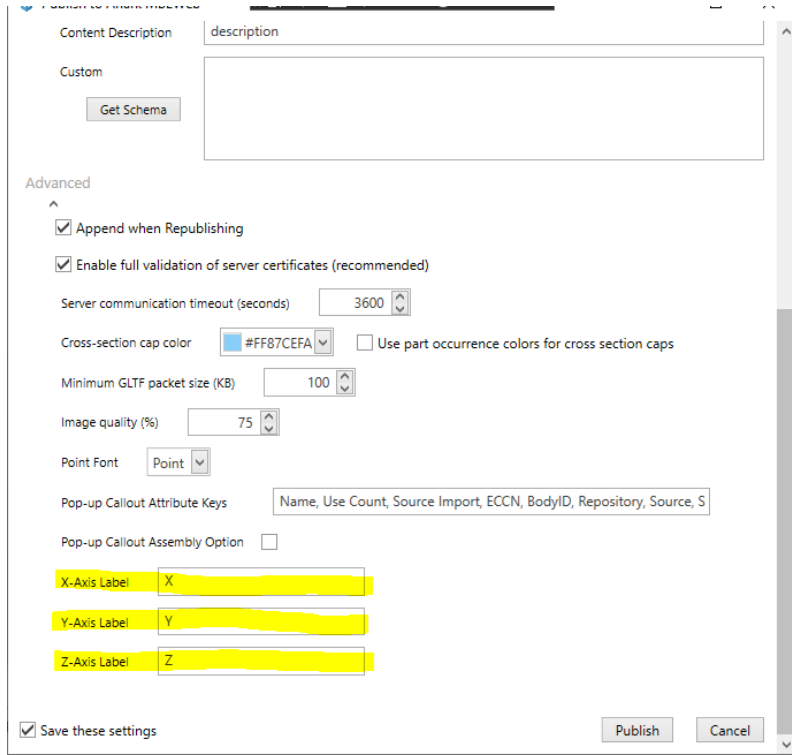

The second is within the “Publish to Anark Collaborate” dialog under advanced. Here there is also the “Save these settings” option to retain the labels within preferences for future use.

Axis labels can be overwritten in recipe when publishing content using Anark Publish.

VIEWING AXIS LABELS IN ANARK COLLABORATE

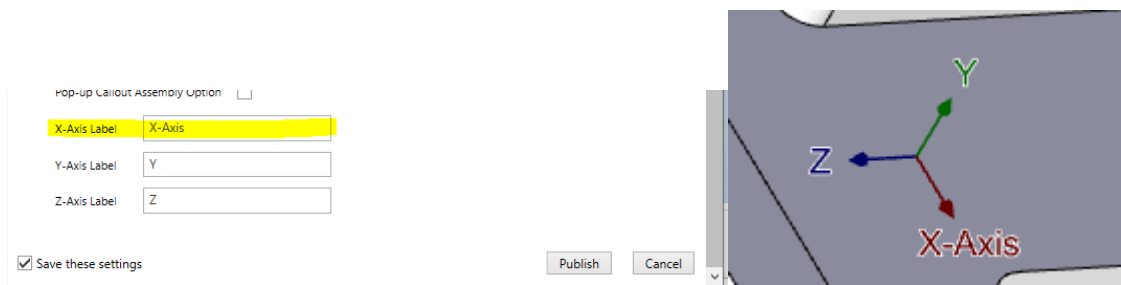

If one modifies a label for publishing, it will be reflected in Anark Collaborate. There is also a background applied to the text to set it apart from the model. This text background color is set to the 3D view background color.



MULTIPLE SELECTIONS

Selecting multiple parts in a 3D model can be done by using a combination of the:

- Control-key
- Marquee selection tool
- CAD Tools Select button

MULTIPLE SELECTIONS WITH THE CONTROL-KEY

Selecting multiple parts in a 3D model can be done by clicking on multiple parts while holding down the control-key. Clicking multiple times on the same part while holding down the control-key will toggle the part to be included/removed from the current selection.

MULTIPLE SELECTIONS WITH THE CONTROL-KEY AND MARQUEE SELECTION TOOL

The marquee selection tool allows you to select multiple parts at once by drawing a rectangle around the parts that you want to select. The rectangle is created by holding down the control-key and then performing a click-and-drag with the mouse. Once you are satisfied with the rectangle, releasing the mouse button will select the parts that are fully within the rectangle.

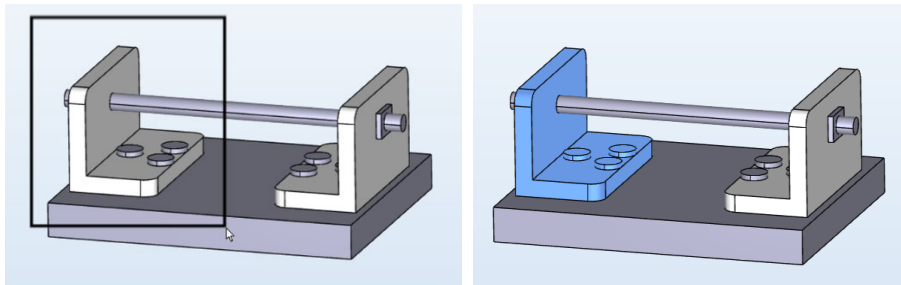

Using the marquee selection tool multiple times on the same part will toggle the part to be included/removed from the current selection.



MULTIPLE SELECTIONS WITH THE CAD TOOLS SELECT BUTTON

If you are on a mobile device and don't have access to a control-key, you can instead enable multiple selection mode by enabling the CAD Tools Select button.

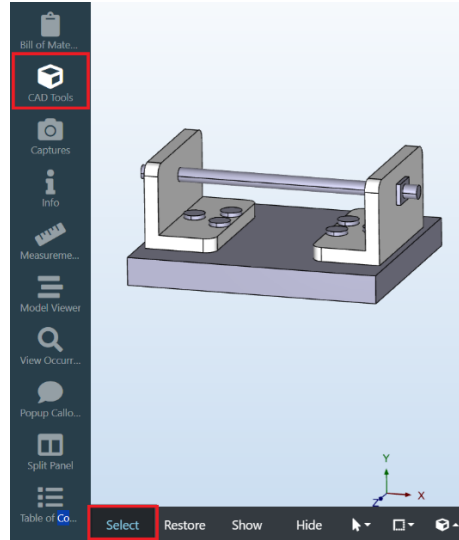

When the Select button is enabled you can perform the multiple selection by single clicking on parts or using the marquee selection tool.

